

**FIBRAIN** ®

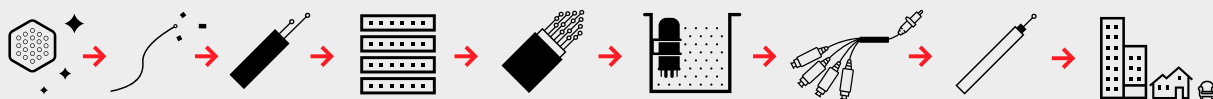

# Distribution Fiber

## PRODUCTS CATALOGUE



Product center → [www.fibrain.com](http://www.fibrain.com)

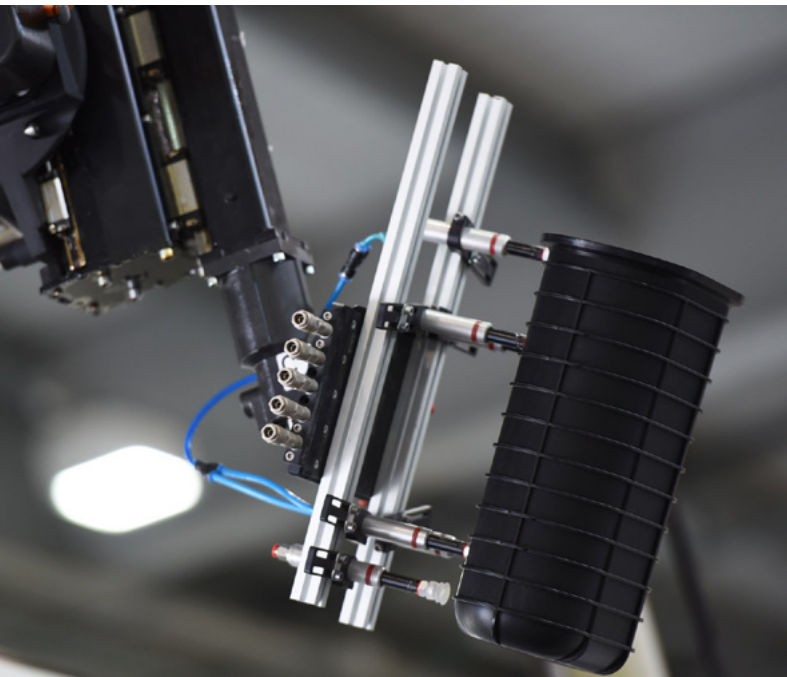
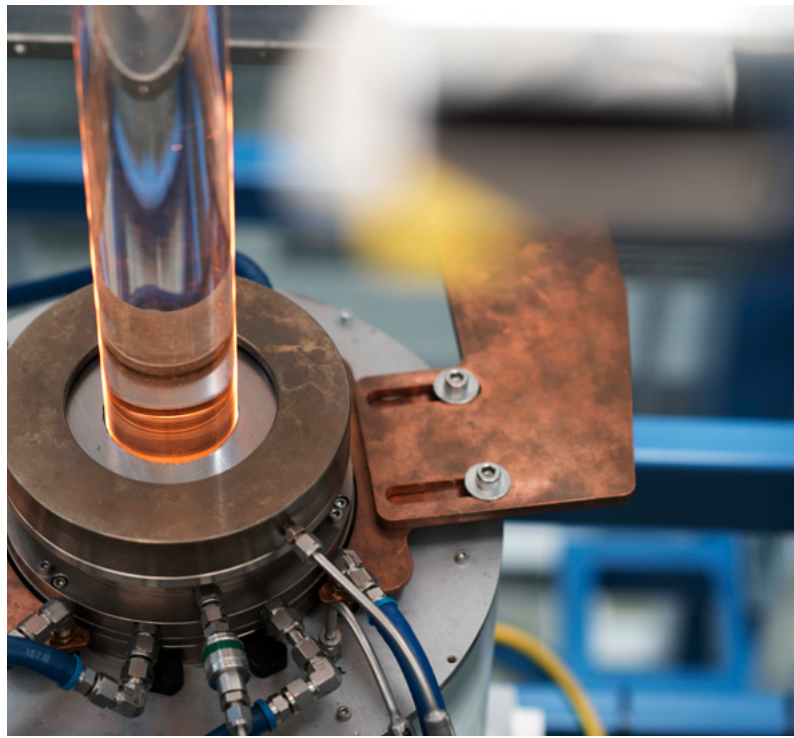





FIBRAIN ®

# Distribution Fiber



**MOUNTING**  
**NUMEROUS**  
**COMPONENTS**  
**ON-SITE**



# Polish producer in photonics and fiber optic sector





# FIBRAIN

**FIBRAIN is a Polish innovator and producer in the fiber optic sector that has been successfully operating on the market for over 30 years now.**

For almost 30 years, we have been connecting people around the globe. As a global player, we know perfectly that safety and stability determine our actions of providing best-in-class services. Every day FIBRAIN cables send hundreds of thousands information to millions of people around the globe, thus only proven solutions, guarantee success.

Our homes, apartments, public buildings and places of work use the networks that have been built on FIBRAIN networks and products. They ensure safety and stability as well as safe data processing.

Since the very beginning we have been facing challenges, which allow us to move forward and invent new solutions. Consequently, we can easily adjust to ever-changing market trends and upon customer request we can produce or adjust each solution to individual needs.

Creating innovative ideas aiming at creating our better future is our ultimate goal and desire. Upon customer request we can produce or adjust each solution to individual needs.

## Our complete product portfolio meets your needs

→ [www.fibrain.com](http://www.fibrain.com)



**Fiber Optics Cables**



**Passive Telecom Optics**



**Connectivity fiber**



**Photonics**



**Distribution fiber**



**Tools, measuring instruments & equipment**



**AirTrack**



**FibrainDATA structured cabling**



**MetroJet**



**Active devices**

**Solid. Thoroughly tested.  
Made in Poland.**



# Business sectors



## INDUSTRIAL

Fiber optic cables  
Installation capabilities  
Special construction



## RENEWABLE ENERGY

Wind power  
Solar & photovoltaics  
Innovations



## MINING

Microduct  
Networks  
Services



## TELECOM

Fiber optic cables  
Data Center  
Distribution



## SHIP & OFFSHORE OIL & GAS

Marine  
Network components  
Transport



Network components  
Special construction  
Pipelines



## POWER PLANT

Networks  
Fiber optic cables  
Fiber optic accessories



## MILITARY

Armoured cables  
Armoured accessories  
Monitoring systems

# Certificates & Recognition

**FIBRAIN meets the highest quality standards, which prove our certificates.**

**ISO 9001:2015**  
Quality Management  
Certificate

**ISO 14001:2004**  
Certificate

**NATO Commercial  
and Government  
Entity Code**



AC 129  
QMS



# Contents

<b>HD 19" Patch panels and accessories</b>	<b>10</b>
<b>19" Patch panels</b>	<b>28</b>
<b>19" Cable shelves and organizers</b>	<b>39</b>
<b>Boxes and cabinets</b>	<b>47</b>
<b>Accessory</b>	<b>62</b>
<b>Outdoor cabinets</b>	<b>68</b>
<b>Closures and distribution boxes</b>	<b>77</b>
<b>Cable reserve frames and boxes</b>	<b>102</b>



# General information

**A fiber optic network is a complex system which consists of many accessories in the form of fiber optic equipment. Each of these element is very important and has a direct impact on the proper operation of the network.**

It is therefore absolutely necessary to use only high quality accessories to meet network's needs and requirements (optical power balance, resistance, operation, fault tolerance). In order to meet all these needs FIBRAIN presents solutions which ensure streamlined network operation. It is also necessary to bear in mind that apart from premium quality equipment, the installation needs to take place and be performed in accordance with proper norms and standards.

## Distribution elements:

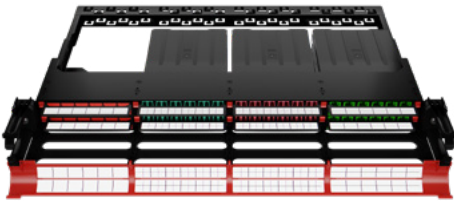

1

**FIBRAIN HD family**



2

**FIBRAIN 19" Patch panels**



3

**Boxes and cabinets**



4

**FIBRAIN fiber optic closures and distribution boxes**



5

**Outdoor cabinets**



6

**Cable reserve frames and boxes**

# 01. HD 19" patch panels and accessories



# FIBRAIN HD family

→ [hd.FIBRAIN.com](http://hd.FIBRAIN.com)

## 1 Patch panels

Scalability / Freedom of arrangement / Modularity

Wide range of applications / Saving precious space in the 19" rack / Quick and easy installation

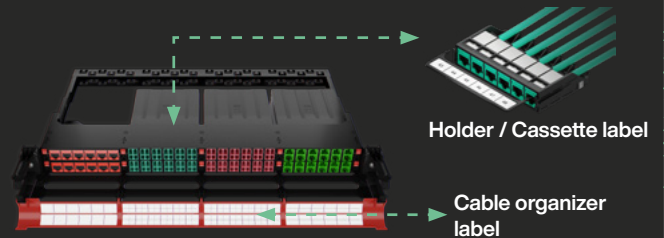

## 2 HD RJ45 modules

Wide range of applications / Saving precious space in the 19" rack / Quick and easy installation

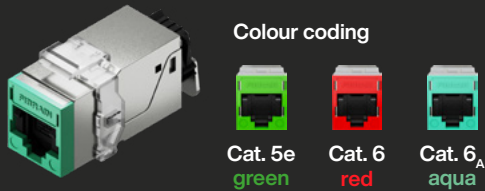

## 3 HD patchcords

6/12 FO variants / SM/MM fibers / PC/APC polishing / Uniboot option

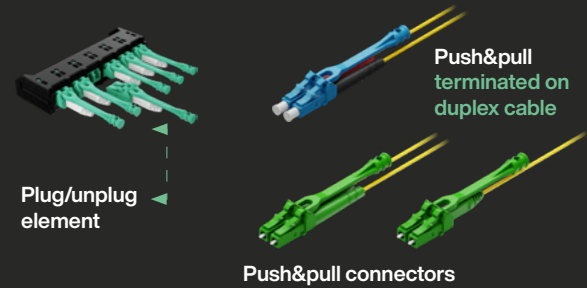

## 4 Harness cables

Wide range of applications / Saving precious space in the 19" rack / Quick and easy installation

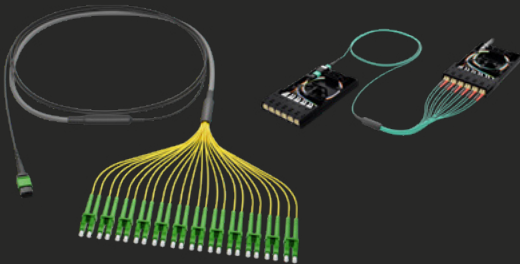

## 5 Copper patchcords

Compact dimensions / Full range of performance / Colour identification



## 6 MPO trunk cables

A/B/C polarization / PC/APC polishing / Gender F/F / F/M, M/F / MTP® standard

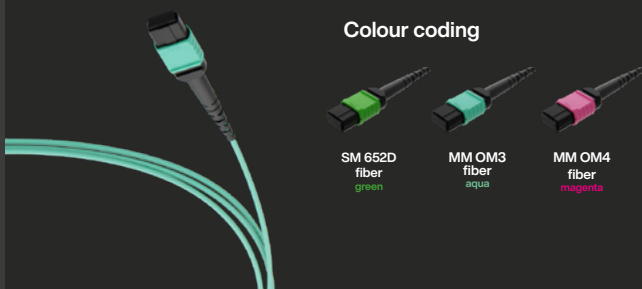

## 7 HD FO cassettes

6/12 FO ports / SC/LC interface support / Closed construction dust protection

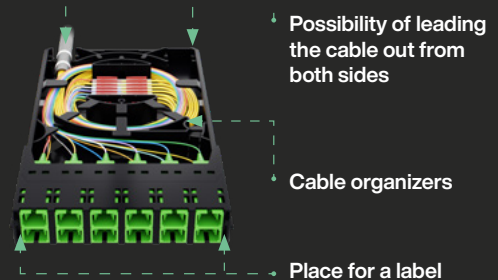

FIBRAIN 

# HD 19" Patch panel

Scalability / Freedom  
of arrangement / Modularity

Wide range of applications /  
Saving precious space in  
the 19" rack  
/ Quick and easy  
installation

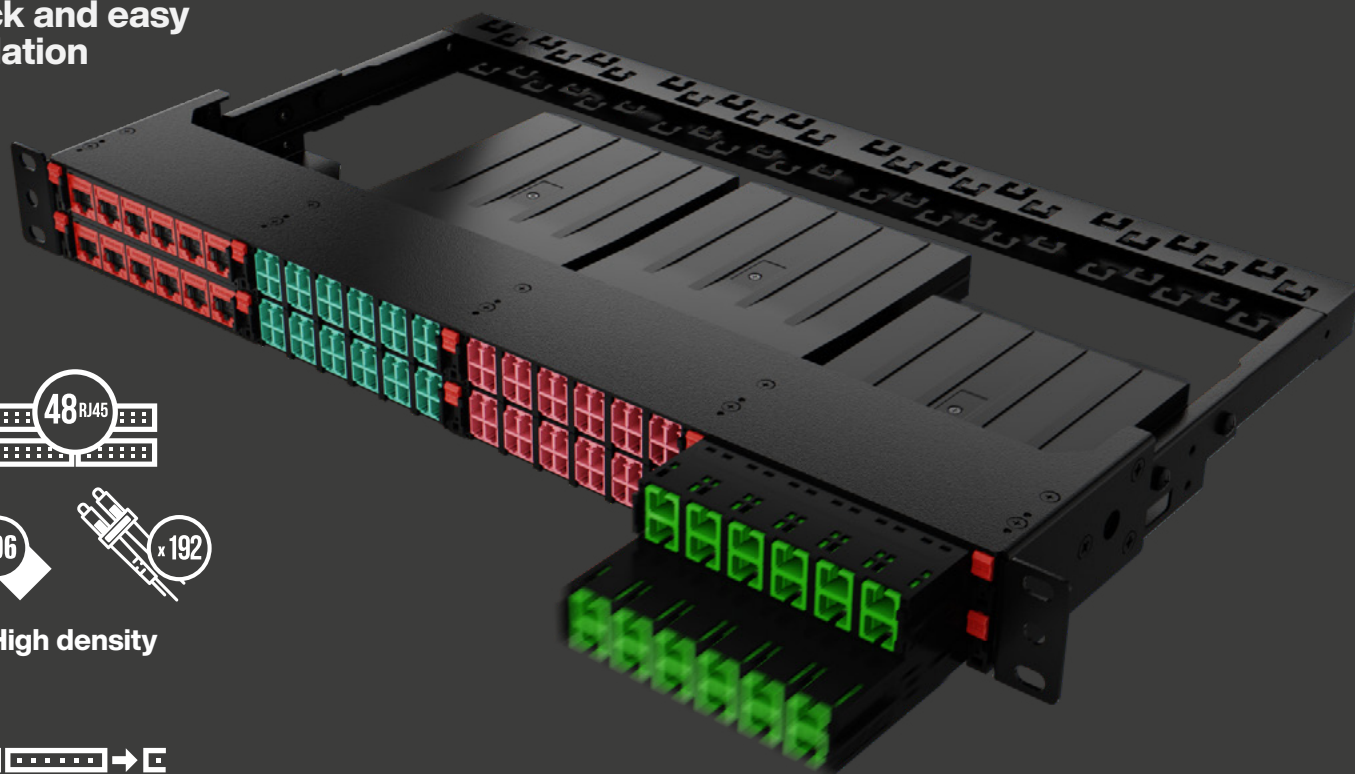

High density



8-slot modular design



FO+Cu hybrid

 MADE IN POLAND

**25** YEAR SYSTEM WARRANTY



# HD 19" patch panels and accessories

## Patch panel for cassettes HD 0,5U, without grounding, empty



- Modular configuration system
  - Possibility for FO assembling
  - Rear basis for cable assembling
- Capacity: 4 slots for FO insertion
- Max ports density
  - 96 ports FO with LCdx
  - 48 ports FO with SCsx
  - 24 ports FO with ST/FC
- Prepared for different type of cassettes
  - Spliced (HD SPL)
  - MPO type
  - Breakout (HD BOT)

### TECHNICAL SPECIFICATION

Dimensions: Height [U] x Width [inch] x Depth [mm]	0,5U x 19" x 250 (U=44,45 mm)
Material	Frame – powder paint coated steel. Guidance – Plastic
IP Protection	IP 20 according to PN-EN 60529
Color [RAL]	Black, RAL 9005
Weight [kg]	0,8
Scope of supply	Frame, empty
Temperature range [°C]	-40 to +70



### VARIANT

Patch panel HD 0,5U for FO cassettes, empty

### REFERENCE NO.

XBU00

# HD 19" patch panels and accessories

## Patch panel for cassettes HD 1U, without grounding, empty



- Modular configuration system
  - Possibility for FO/Cu assembling
  - Rear bar for cable assembling
  - Optional cable manager installed at the front
- Capacity: 8 slots for FO/Cu insertion
- Max ports density
  - 48 ports/1U for copper
  - 192 ports for FO (for LCdx)
  - 96 ports FO wit SCsx
  - 48 ports FO with FC/ST
- Prepared for different type of cassettes
  - Spliced (HD SPL)
  - MPO type
  - Breakout (HD BOT)

### TECHNICAL SPECIFICATION

Dimensions: Height [U] x Width [inch] x Depth [mm]	1U x 19" x 250 (U=44,45 mm)
Material	Frame – powder paint coated steel. Guidance – Plastic
IP Protection	IP 20 according to PN-EN 60529
Color [RAL]	Black, RAL 9005
Weight [kg]	1,2
Scople of supply	Frame, empty
Temperature range [°C]	-40 to +70



### VARIANT

Patch panel for cassettes HD 1U, empty

### REFERENCE NO.

XPU00

# HD 19" patch panels and accessories

## Patch panel HD 0.5U



- Fiber optic patch panel in the form of a fixed shelf with removable cover
- Capacity: up to 2 splice tray SCM-A-xx, up to 4 adapter holder
- Maximum splice capacity: 48
- Range of supported connectors: LCd, SC, E2000, ST, FC – MM/SM

### TECHNICAL SPECIFICATION

Dimensions: Height [U] x Width [inch] x Depth [mm]	0,5 U x 19" x 230 (U=44,45 mm)
Material	Frame – powder paint coated steel. Guidance – Plastic
IP Protection	IP 20 according to PN-EN 60529
Color [RAL]	Black, RAL 9005
Weight [kg]	1,56
Scope of supply	Frame, empty
Temperature range [°C]	-40 to +70



1U splice panel max. 48 splices

### VARIANT

### REFERENCE NO.

Patch panel HD 0.5U, equipped in 48 SCA adapters, 48x SCA G657A1 pigtails	XAU10-51ID
Patch panel HD 0.5U, equipped in 48 SC adapters, 48x SC G657A1 pigtails	XAU10-41ID
Patch panel HD 0.5U, equipped in 24 LC DX adapters, 48x LC G657A1 pigtails	XAU10-21IC
Patch panel HD 0.5U, equipped in 24 LCA DX adapters, 48x LCA G657A1 pigtails	XAU10-31IC

# HD 19" patch panels and accessories

## Patch panel HD 1U



- Fiber optic patch panel in the form of a fixed shelf with removable cover
- Capacity: up to 4 splice tray SCM-A-xx, up to 8 adapter holder
- Max. splice capacity: 96
- Range of supported connectors: LCd, SC, E2000, ST, FC – MM/SM

### TECHNICAL SPECIFICATION

Dimensions: Height [U] x Width [inch] x Depth [mm]	1U x 19" x 230 (U=44,45 mm)
Material	Frame – powder paint coated steel. Guidance – Plastic
IP Protection	IP 20 according to PN-EN 60529
Color [RAL]	Black, RAL 9005
Weight [kg]	1,86
Scope of supply	Frame, empty
Temperature range [°C]	-40 to +70

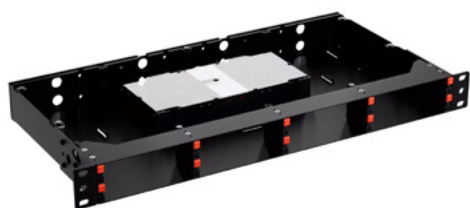

1U splice panel max. 96 splices

### VARIANT

### REFERENCE NO.

Patch panel HD 1U, equipped in 96 SCA adapters, 96x SCA G657A1 pigtails	XDU10-51IE
Patch panel HD 1U, equipped in 96 SC adapters, 96x SC G657A1 pigtails	XDU10-41IE
Patch panel HD 1U, equipped in 48 LC DX adapters, 96x LC G657A1	XDU10-21ID
Patch panel HD 1U, equipped in 48 LCA DX adapters, 96x LCA G657A1 pigtails	XDU10-31ID



# HD 19" patch panels and accessories

## Fibrain extendable Patch panel HD 0.5U for 48 splices



- Height 0.5U
- Maximum adapter capacity: 48xSC SX/ LC DX/ E2000 (4 adapter holders)
- Full extension on telescopic rails
- Front plate equipped with handles for easy opening
- Maximum splice capacity: 48
- Range of supported connectors: LCd, SC, E2000 – MM/SM

### TECHNICAL SPECIFICATION

Dimensions: Height [U] x Width [inch] x Depth [mm]	0.5U x 19" x 284
Material	Powder painted steel

Number of adapter slots	LC DX, ST, FC adapter number	SC, E2000 adapter number
6	6	6
12	12	12
24	24	24
48	-	48



### VARIANT

### REFERENCE NO.

Extendable patch panel HD 0.5U, equipped in 48 SCA adapters, 48x SCA G657A1 pigtails	XCU10-51ID
Extendable patch panel HD 0.5U, equipped in 48 SC adapters, 48x SC G657A1 pigtails	XCU10-41ID
Extendable patch panel HD 0.5U, equipped in 24 LC DX adapters, 48x LC G657A1 pigtails	XCU10-21IC
Extendable patch panel HD 0.5U, equipped in 24 LCA DX adapters, 48x LCA G657A1 pigtails	XCU10-31IC

# HD 19" patch panels and accessories

## Dual section patch panel HD 1U



- Height 1U, dual section patch panel
- 0.5U – section for cable tube reserve
- 0.5U – removable section for adapters and splice cassette
- Maximum splice capacity: 48
- Full extension on telescopic rails
- Holder for cable central member element
- Range of supported connectors: LCd, SC, E2000, ST, FC – MM/SM

### TECHNICAL SPECIFICATION

Dimensions: Height [U] x Width [inch] x Depth [mm]      1U x 19" x 260 (U=44,45 mm)

Material      Powder painted steel

Number of adapter slots	LC DX, ST, FC adapter number	SC, E2000 adapter number
6	6	6
12	12	12
24	24	24
48	-	48

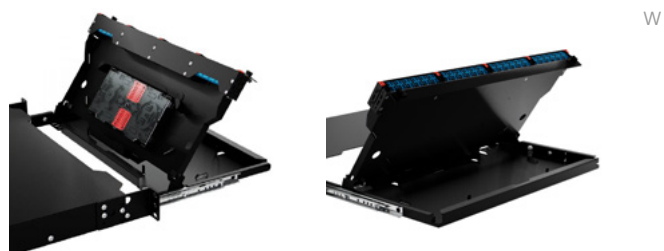

### VARIANT

### REFERENCE NO.

Dual section patch panel HD 1U, equipped in 48 SCA adapters, 48x SCA G657A1 pigtails

XEU10-51ID

Dual section patch panel HD 1U, equipped in 48 SC adapters, 48x SC G657A1 pigtails

XEU10-41ID

Dual section patch panel HD 1U, equipped in 24 LC DX adapters, 48x LC G657A1 pigtails

XEU10-21IC

Dual section patch panel HD 1U, equipped in 24 LCA DX adapters, 48x LCA G657A1 pigtails

XEU10-31IC

# HD 19" patch panels and accessories

## Patch panel for cassettes HD 3U, empty



- Modular configuration system
  - Possibility for FO/Cu assembling
  - Suitable for SPL cassettes, MPO cassettes, BOT cassettes
- Capacity: 20 slots for FO/Cu insertion
- Max. port density
  - 240 ports for SC SX FO
  - 480 ports for LCdx FO
  - 120 ports for ST/FC FO
  - 120 ports/3U for copper
- Full range of connectors
  - RJ45/u (unshielded) – kat.5, kat.6, kat.6<sub>A</sub>
  - LCdx, SC, FC, ST – MM/SM

### TECHNICAL SPECIFICATION

Dimensions: Height [U] x Width [inch] x Depth [mm]	3U x 19" x 185 (U=44,45 mm)
Material	Frame – powder paint coated steel. Guidance – Plastic
IP Protection	IP 20 according to PN-EN 60529
Color [RAL]	Black, RAL 9005
Weight [kg]	2,65
Scope of supply	Frame, empty
Temperature range [°C]	-40 to +70



3U modular max. 120p (CU)/480p (FO LC Duplex)

### VARIANT

Patch panel HD 3U for cassettes without grounding, empty

### REFERENCE NO.

XFU00

# HD 19" patch panels and accessories

## FO adapter holder, HD, Black



- Fits a single slot in HD patch panel
- Available in 6 or 12 ports configuration
- Suitable for LCdx, SC, E2000, ST, FC interface
- Fully equipped with adapters FO holder for HD patch panel (quantity depends on cassette type)
- Dedicated holes for label
- Holder Height: ½U

### TECHNICAL SPECIFICATION

Dimensions: Height x Width x Depth [mm] 21 x 100 x 37

Material Plastic

### VARIANT

### REFERENCE NO.

FO adapter holder HD 6 x SC/APC, SM, G.657A1

XMI1051IA

FO adapter holder HD 12 x SC/APC, SM, G.657A1

XMN1051IB

FO adapter holder HD 6 x LCdx, SM, G.657A1

XMI1021IA

FO adapter holder HD 12 x LCdx, SM, G.657A1

XMN1021IB



# HD FO cassettes

## MPO / Breakout / FO splice cassettes

### Fiber optic splice cassette

Equipped with 6/12 SC adapters



6/12 FO ports



SC/LC interface  
support



Closed construction  
– dust protection

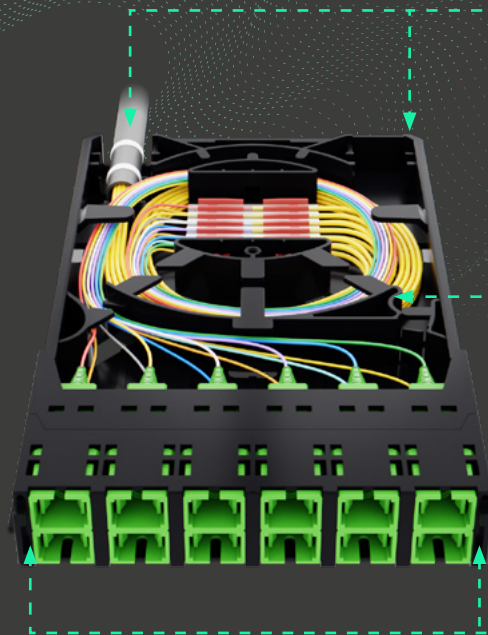

Possibility of leading  
the cable out from  
both sides

Cable  
organizers

Place for  
a label

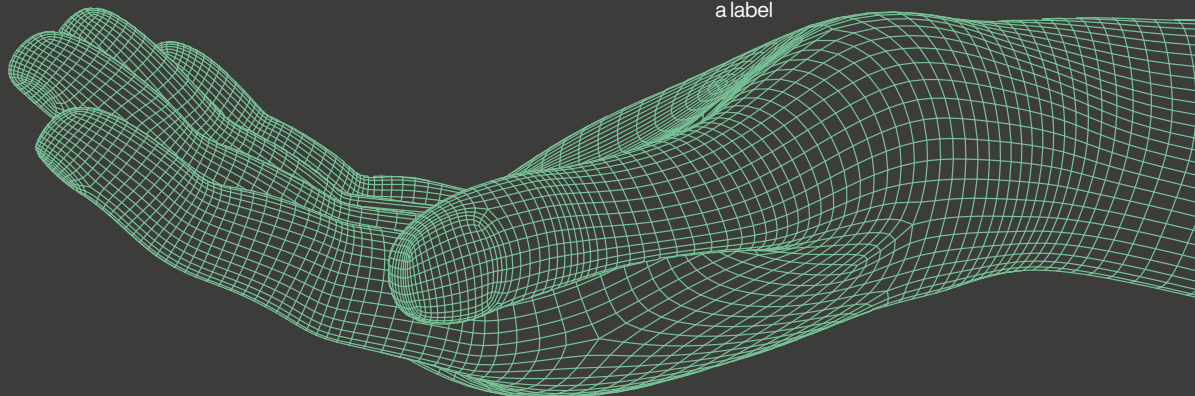

## Fiber optic breakout cassette

Equipped with 6/12 SC adapters



6/12 FO ports



SC/LC interface support

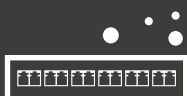

Closed construction  
- dust protection



Possibility of leading the cable out from both sides

Cable organizers

Place for a label

## Fiber optic MPO cassette

Equipped with 6/12 SC adapters



A/B/C polarization



6/12 FO ports



SC/LC interface support



Closed construction  
- dust protection

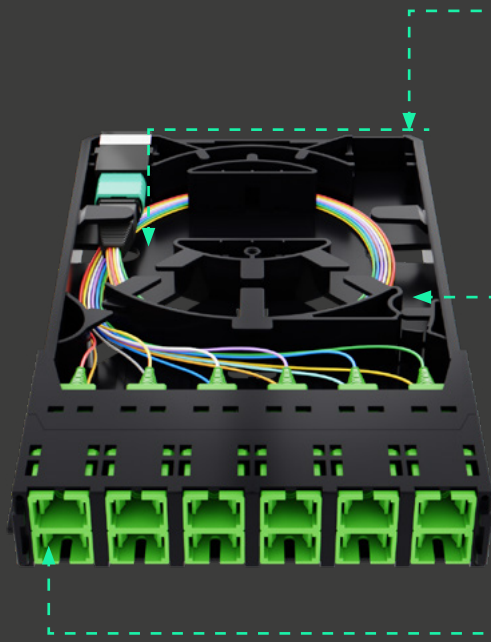

Possibility of leading the cable out from both side

Cable organizers

Place for a label

# HD 19" patch panels and accessories

## FO breakout cassette HD, black

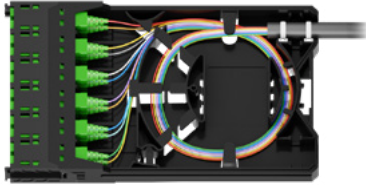

- Fits a single slot in HD patch panel
- Easy assembling by modular construction
- Available in 6 or 12 ports configuration
- Suitable for LCdx, SC, E2000, ST, FC interface
- Fully equipped FO breakout cassette (quantity of the equipment depends on cassette type)
- Adapted for mounting pre-connectorized cables of the TEF HD (THxx) series
- Cassette height: ½U

### TECHNICAL SPECIFICATION

Dimensions: Height x Width x Depth [mm]	21 x 100 x 169
Material	Plastic

CASSETTE TYPE	E2/E2A	SC/SCA	LC/LCA	ST/FC
6 ports	4 simplex adapters	6 simplex adapters	6 duplex adapters	6 adapters
12 ports	8 simplex adapters	12 simplex adapters	12 duplex adapters	NA

VARIANT	REFERENCE NO.
BOT cassette 6 x SC/APC, SM, G.657A1	XMH1051A
BOT cassette 12 x SC/APC, SM, G.657A1	XMR1051B
BOT cassette 6 x LCdx, SM, G.657A1	XMH1021A
BOT cassette 12 x LCdx, SM, G.657A1	XMR1021B



# HD 19" patch panels and accessories

## FO splice cassette HD, black

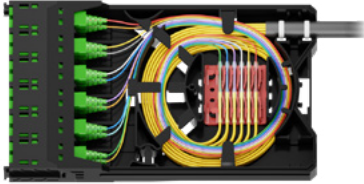

- Fits a single slot in HD patch panel
- Easy assembling by modular construction
- Available in 6 or 12 ports configuration
- Suitable for LCdx, SC, E2000, ST, FC interface
- Fully equipped FO breakout cassette (quantity of the equipment depends on cassette type)
  - FO adapters
  - Fiber optic pigtailed
  - Splice magazine
  - Splice protectors
- Cassette height: 1/2U

### TECHNICAL SPECIFICATION

Dimensions: Height x Width x Depth [mm]	21 x 100 x 169
Material	Plastic

CASSETTE TYPE	E2/E2A	SC/SCA	LC/LCA	ST/FC
6 ports	4 simplex adapters 4 pigtailed Splice magazine 4 splice protectors	6 simplex adapters 6 pigtailed Splice magazine 6 splice protectors	6 duplex adapters 12 pigtailed Splice magazine 12 splice protectors	6 adapters 6 pigtailed Splice magazine 6 splice protectors
12 ports	8 simplex adapters 8 pigtailed Splice magazine 8 splice protectors	12 simplex adapters 12 pigtailed Splice magazine 12 splice protectors	12 duplex adapters 24 pigtailed 2 splice magazine 24 splice protectors	NA

VARIANT	REFERENCE NO.
SPL cassette 6 x SC/APC, SM, G.657A1	XMG1051IA
SPL cassette 12 x SC/APC, SM, G.657A1	XMP1051IB
SPL cassette 6 x LCdx, SM, G.657A1	XMG1021IA
SPL cassette 12 x LCdx, SM, G.657A1	XMP1021IB

# HD 19" patch panels and accessories

## FO MPO cassette HD, black

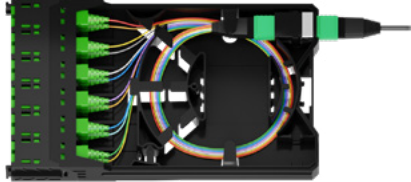

- Fits a single slot in HD patch panel
- Easy assembling by modular construction
- Available in configuration with 1 x MPO and 2 x MPO
- Available in 6 or 12 ports configuration
- A/B connections
- Suitable for LCdx, SC, E2000, ST, FC interface (for E2000 up to 8 adapters max.)
- Fully equipped FO MPO cassette (quantity of the equipment depends on cassette type)
  - FO adapters
  - Direct split
  - MPO adapter
- Cassette height: ½U

### TECHNICAL SPECIFICATION

Dimensions: Height x Width x Depth [mm] 21 x 100 x 169

Material Plastic

### CASSETTE TYPE

	1 x MPO	2 x MPO
6 ports SC/SCA/E2/E2A/ST/FC	6 simplex adapters: SC/SCA/E2/E2A/ST/FC/FCA Direct split MPO-6xSC/SCA/E2/E2A/ST/FC/FCA MPO adapter	12 simplex adapters: SC/SCA 2 Direct split MPO-6xSC/SCA 2 MPO adapter
12 ports SC/SCA	12 simplex adapters: SC/SCA Direct split MPO-12xSC/SCA MPO adapter	NA
6 ports LC/LCA	6 duplex adapters: LC/LCA Direct split MPO-6xLCdx/LCAdx MPO adapter	NA
12 ports LC/LCA	12 duplex adapters: LC/LCA Direct split MPO-12xLCdx/LCAdx MPO adapter	12 duplex adapters: LC/LCA 2 Direct split MPO-6xLCdx/LCAdx 2 MPO adapter

### VARIANT

### REFERENCE NO.

FO cassette, 1 x MPO/f, typ A, 6 x LCdx, SM, G.657A1	XMA1021IA
FO cassette, 1 x MPO/f, typ A, 12 x SC, SM, G.657A1	XMA1041IB
FO cassette, 2 x MPO/f, typ A, 12 x LCdx, SM, G.657A1	XMJ1021IB
FO cassette, 1 x MPO/m, typ B, 12 x SC /APC, SM, G.657A1	XMD1051IB

# HD 19" patch panels and accessories

## Pivot swivel patch panel with side access PSR-HD-A0



- SCM-A splice cassettes
- Splice capacity:
  - 96 splices in 1U (6 adapter holders)
  - 192 splices in 2U (12 adapter holders)
  - 288 splices in 3U (18 adapter holders)
- Patch panel installation on back or front rack profile
- Panel available in rotating left or right side of patch panel (depends on version)
- Possibilities of termination cables on side or back of patch panel
- Hinged flap of patch panel protects patchcords from damages
- 2U and 3U patch panels can be combined with RT-01 tube divider

### TECHNICAL SPECIFICATION

Height	1U	2U	3U
Width	19"		
Depth [mm]	315		
Max. number of adapters	72	144	216
Max. number of splices	96	192	288
Max. number of splice trays	4	8	12
Max. line cable diameter [mm]	12		
Casing material	powder painted steel		

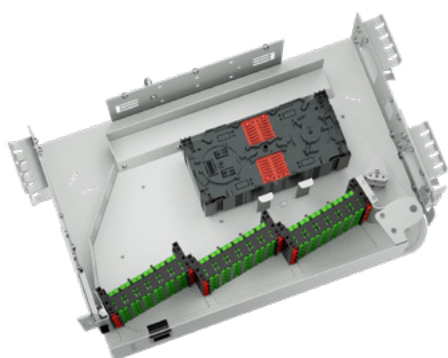

### VARIANT

FIBRAIN HD 1U 19" rotational patch panel equipped in 72x SCA adapters, 4x SCM-A-24H cassettes, RAL 7035

FIBRAIN HD 2U 19" rotational patch panel equipped in 144x SCA adapters, 8x SCM-A-24H cassettes, RAL 7035

FIBRAIN HD 3U 19" rotational patch panel equipped in 216x SCA adapters, 12x SCM-A-24H cassettes, RAL 7035

### REFERENCE NO.

PSR-HD-A0-01-R-042-072121-00000000-000-1

PSR-HD-A0-02-R-082-144121-00000000-000-1

PSR-HD-A0-03-R-122-216121-00000000-000-1



# HD 19" patch panels and accessories

## Cable manager with label field for HD patch panel, 1U



- For patch cords management
- Installed on the front of HD patch panel, additional space in 19" rack is not necessary
- Equipped with a hinged flap with an adhesive label to describe relations

### TECHNICAL SPECIFICATION

Dimensions: Height [mm] x Width [mm] x Depth [mm]	44 (1U) x 491 (19") x 79
Material	Plastic
Weight [kg]	0,1
Scope of supply	Complete organizer without 19" mounting set



Integrated patchcord cable organizer for HD patch panel, 1U, red front



Integrated patchcord cable organizer for HD patch panel, 1U, grey front



Cable organizer for HD patch panel, transparent

### VARIANT

### REFERENCE NO.

Cable manager with label field for HD patch panel, red	ORG-HD-1U-0
Cable manager with label field for HD patch panel, grey	ORG-HD-1U-1
Cable manager with label field for HD patch panel, transparent	ORG-HD-1U-2

# HD 19" patch panels and accessories

## HD labelling field

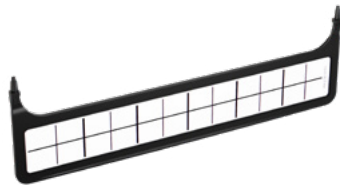

- Label with a set of self-adhesive description fields
  - 1x 6 port labelling field
  - 1x 12 port labelling field
  - 1x 24 port labelling field

### TECHNICAL SPECIFICATION

Dimensions: Height [U] x Width [mm] x Depth [mm]	0,5U x 100 x 66 (U=44,45 mm)
Material	Plastic
IP protection	N/A
Color [RAL]	Black, RAL 9005
Weight [kg]	0,05
Scope of supply	1 label, 3 self-adhesive description fields
Temperature range [°C]	-40 to +70

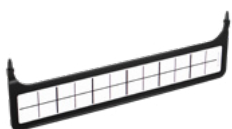

1 x 24 port labelling field

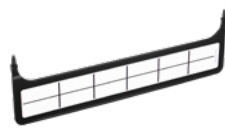

1 x 12 port labelling field

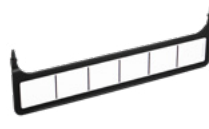

1 x 6 port labelling field

### VARIANT

HD labelling field

### REFERENCE NO.

XL00

# HD 19" patch panels and accessories

## HD blind cover

- Blind cover for empty slot in HD patch panel



### TECHNICAL SPECIFICATION

Dimensions: Height [U] x Width [mm] x Depth [mm]	0,5U x 100 x 35 (U=44,45 mm)
Material	Plastic
IP protection	N/A
Color [RAL]	Black, RAL 9005
Weight [kg]	0,1
Scope of supply	1 module
Temperature range [°C]	-40 to +70

### VARIANT

### REFERENCE NO.

Blind cover for empty slot in HD patch panel, black	XBCS0
Blind cover for empty slot in HD patch panel, grey	XBCS1

# 02. 19" Patch panels





**Equipment presented in this section is a very important part of fiber optic network. It is also the end or the beginning of each optical path.**

The construction of the equipment is based on telescopic fiber optic, rotating or modular patch panels. Each of these solution is specifically designed and depends on network topology, number of optical points, as well as quantity and capacity of fiber optic cables.

These solutions are often linked to optical network, thus our proposal concentrates the most significant elements of xWDM network as it integrates them in common patch panels which are equipped with specialized front panels.

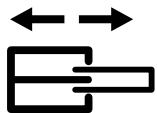

**Full extension**

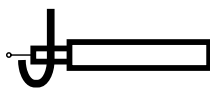

**Holder for cable central member**



**SCM-C splice tray**



**SCM-A splice cassette**

# 19" patch panels

## PST-Ax Premium telescopic patch panel



- Available in 1U and 2U
- Full opening on telescopic rails
- Cable entries in a rear part of the shelf (4 pcs in 1U and 8 pcs in 2U) are available in two configuration:
  - perpendicular cable entries in PST-A1-x type
  - cable entries at an angle of 45° and perpendicular in PST-A2-x type
- Internal perforation to manage tubes and fibers
- Faceplates ready for mounting adapters without screws
- Optional front shelf to facilitate the management of patchcords
- Adjustable side handles
- Front plates can be optionally locked with a key
- Holder for the strength element of cable

### TECHNICAL SPECIFICATION

	PST-Ax-01	PST-Ax-02
Dimensions: Height [U] x Width [inch] x Depth [mm]	1U x 19" x 255	2U x 19" x 255
Max. cassette capacity	4	8
Material	Powder painted steel	



FIBRAIN 1U telescopic fiber optic patch panel with front plate



FIBRAIN 2U telescopic fiber optic patch panel with front plate



### VARIANT

### REFERENCE NO.

FIBRAIN 1U telescopic fiber optic patch panel, without front plate and accessories, grey	PST-A1-01
FIBRAIN 2U telescopic fiber optic patch panel, without front plate and accessories, grey	PST-A1-02
FIBRAIN 1U telescopic fiber optic patch panel, with 24 SC SX adapter front plate, grey	PST-A1-01070
FIBRAIN 2U telescopic fiber optic patch panel, with 72 SC SX adapter front plate, grey	PST-A1-02140

# 19" patch panels

## PST-Ax Premium telescopic patch panel

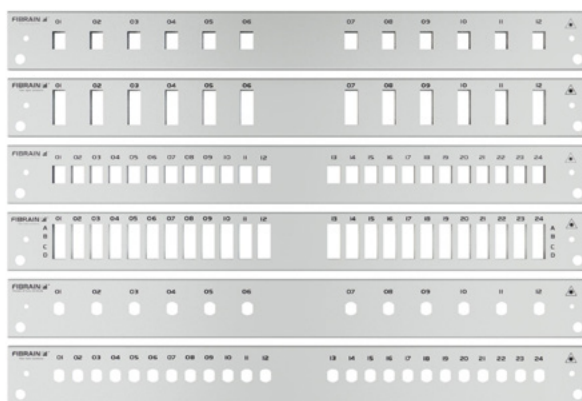
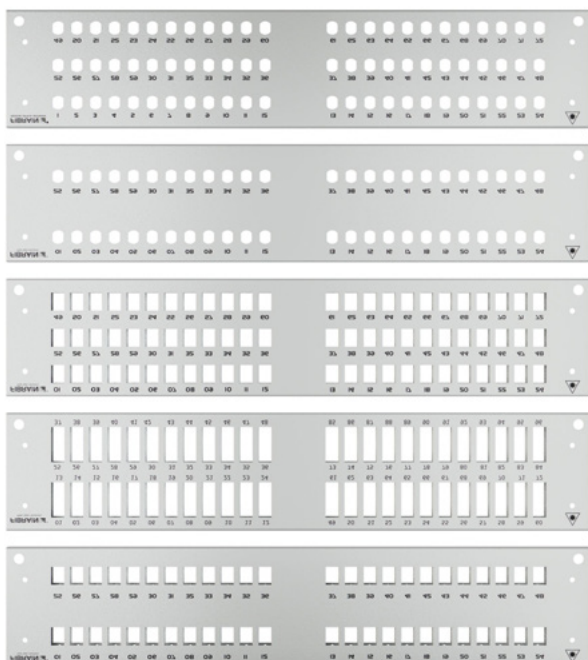

PST-Ax front plates

VARIANT

REFERENCE NO.

FIBRAIN face plate 1U 12xSC simplex, MTRJ, E2000, LC RAL7035	FB2031
FIBRAIN face plate 1U 12xSC duplex RAL7035	FB2032
FIBRAIN face plate 1U 24xST, FC simplex RAL7035	FB2033
FIBRAIN face plate 1U 24xSC simplex, MTRJ, E2000, LC RAL7035	FB2034
FIBRAIN face plate 1U 24xSC duplex RAL7035	FB2035
FIBRAIN face plate 2U 48xST, FC simplex RAL 7035	FB2043
FIBRAIN face plate 2U 48xSC simplex, MTRJ, E2000, LC RAL7035	FB2044
FIBRAIN face plate 2U 48xSC duplex RAL 7035	FB2045
FIBRAIN face plate 2U 72xSC simplex, MTRJ, E2000, LC RAL7035	FB2046

# 19" patch panels

## PSS-A Extendable standard patch panel



- Height 1U
- Full extension shelf with integrated front plate
- Simple construction
- Available for 12 or 24 adapters SC SX/ SC DX/ FC / ST
- Cable central member holder
- Available in equipped version with adapters and pigtails

### TECHNICAL SPECIFICATION

Dimensions: Height [U] x Width [inch] x Depth [mm]	1U (U=44 mm) x 19" (482,6 mm) x 201
Max. splice cassette quantity	3
Material	Powder coated steel / Plastic guides



Internal view of patch panel

VARIANT	REFERENCE NO.
FIBRAIN extendable standard patch panel 1U 19" with front plate 12 x SC SX	PSS-A0-01050
FIBRAIN extendable standard patch panel 1U 19" with front plate 24 x SC DX	PSS-A0-01030
FIBRAIN extendable standard patch panel 1U 19" with front plate 24 x SC SX	PSS-A0-01020

# 19" patch panels

## FIBRAIN 1U modular patch panel



- Possibility of mounting PS-01 and PS-M1 modules
- High capacity up to 72 fibers in 1U
- Possibility of install up to 9 cable gland M16 in entry ports
- Internal perforation to fix entry cables
- Clear management of fiber optic
- As a standard modular patch panel is equipped with 3 pcs of module cover and 9 pcs of membrane cable entry

### TECHNICAL SPECIFICATION

Max. fibre capacity	72
Max. module capacity	3
Number of cable entry	9
Max. diameter of cable [mm]	14
Dimensions: Height x Width x Depth [mm]	44 x 484,6 x 291
Material	Powder painted steel



### VARIANT

1U modular patch panel

### REFERENCE NO.

PS-19-1-3PS.V0



# 19" patch panels

## FIBRAIN modular patch panel PS-19-3-0.PRO

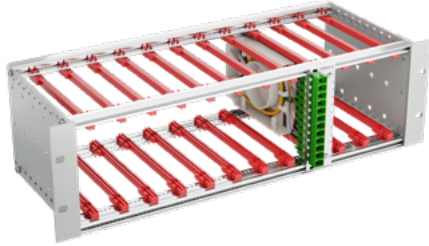

- Modular configuration system - possibility of equipping with PS-01 spliced modules or PS-M1 MPO modules
- Frame capacity 12 modules
- Max. capacity - 144 fibers for SC sx / E2000 sx / ST versions / 288 fibers for LC Quad version
- Easy and fast installation of modules
- Light and strong aluminum construction

### TECHNICAL SPECIFICATION

Dimensions: Height [U] x Width [inch] x Depth [mm]	3U (U=44 mm) x 19" (482,6 mm) x 160
Max. splice cassette quantity	3
Material	Aluminium / ABS

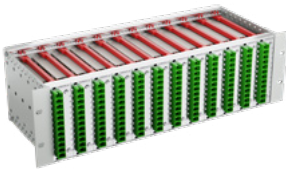

View of modular patch panel with 12 modules

### VARIANT

3U Modular patch panel for 12 modules PS-01/PS-M1, open

### REFERENCE NO.

PS-19-3-0.PRO

# 19" patch panels

## FIBRAIN patch panel module PS-M1



- Max. capacity - 2 direct split MTP/MPO
- Front plate available for SC, E2000, LC quad, FC, ST adapters
- 2 slots for MTP/MPO in rear part of the module
- Module ready for mounting
- Compatible with modular patch panel PS-19-3-0.PRO and PS-19-1-3PS.V0

### TECHNICAL SPECIFICATION

Dimensions: Height x Width x Depth [mm]	128 x 35 x 200
Material	Aluminium / ABS

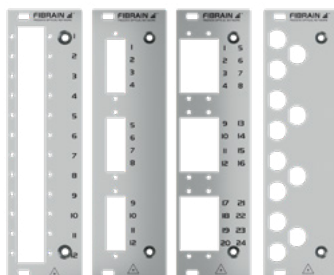
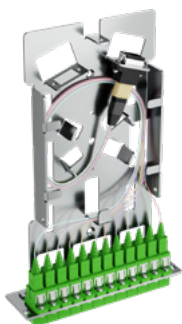

### VARIANT

FIBRAIN patch panel module equipped in 12 x SC APC SX adapters,  
1 x MTP APC adapter + direct split MTP/SC

FIBRAIN patch panel module equipped in 6 x LC PC quad adapters,  
2 x MTP adapters, 2 x MTP/LC direct split

### REFERENCE NO.

PS-M1-A-1-11G202-121021-11

PS-M1-A-3-21G203-061051-21

# 19" patch panels

## FIBRAIN patch panel module PS-01



- Max. capacity 24 splices
- Front plates available for SC, E2000, LC quad, FC, ST adapters
- Modules ready for assembly
- Dedicated tray for a spare fiber
- Modules compatible with modular patch panels PS-19-3-0.PRO and PS-19-1-3PS.V0

### TECHNICAL SPECIFICATION

Dimensions: Height x Width x Depth [mm]	128 x 35 x 200
Material	Aluminium / ABS

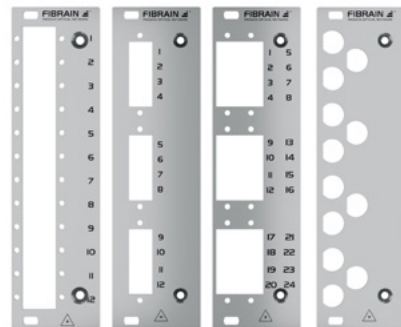
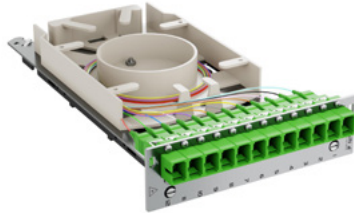

### VARIANT

FIBRAIN patch panel module equipped in 12 x SC APC adapters

FIBRAIN patch panel module equipped in 12 x SC APC adapters, 12 x G657A1 pigtails, 12 x splice sleeves

FIBRAIN patch panel module equipped in 6 x LC quad adapters, 24 x G657A1 pigtails, 24 x splice sleeves

### REFERENCE NO.

PS-01-0-0-121021-00000-000

PS-01-D-1-121011-12G01-121

PS-01-D-3-061051-24G03-241

# 19" patch panels

## PSR-A Pivot swivel patch panel

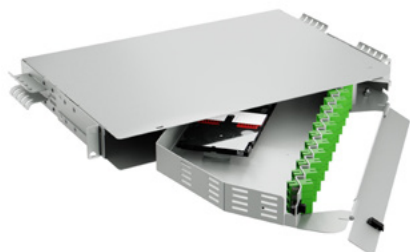

- SCM-A splice cassettes
- Splice capacity: 48 fibers in 1U / 96 fibers in 2U / 144 fibers in 3U
- Patch panel installation on back or front rack profile
- Panel available in rotating left or right side of patch panel (depends on version)
- Possibilities of termination cables on side or back of patch panel
- Hinged flap of patch panel protects patchcords from damages
- 2U and 3U patch panels can be combined with RT-01 tube divider

TECHNICAL SPECIFICATION	PSR-A0-01 / PSR-A0-B1	PSR-A0-02 / PSR-A0-B2	PSR-A0-03 / PSR-A0-B3
Dimensions: Height [U] x Width [inch] x Depth [mm]	1U x 19" x 315	2U x 19" x 315	3U x 19" x 315
Max. number of fibers	48	96	144
Max. number of splices	48	96	144
Max. number of splice trays	2	4	6
Max. line cable diameter [mm]	12	12	12
Casing material	powder painted steel		



View of 1U patch panel



View of 2U patch panel



View of 3U patch panel

### VARIANT

FIBRAIN fiber pivot swivel patch panel 1U 19", right-sided, equipped in 4 x SCM-A-24H splice trays

FIBRAIN fiber pivot swivel patch panel 2U 19", right-sided, equipped in 8 x SCM-A-24H splice trays

FIBRAIN fiber pivot swivel patch panel 3U 19", right-sided, equipped in 12 x SCM-A-24H splice trays

### REFERENCE NO.

PSR-A0-01-R-41-00000-0000000-000

PSR-A0-02-R-81-00000-0000000-000

PSR-A0-03-R-121-00000-0000000-000

# 19" patch panels

## PSR-B Pivot swivel patch panel

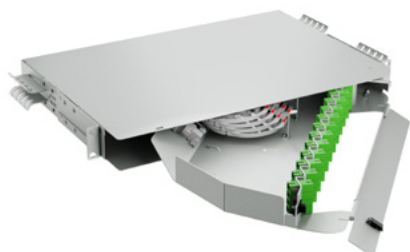

- SCM-C-12H splice cassettes
- Capacity up to: 48 fibers in 1U / 96 fibers in 2U / 144 fibers in 3U
- Patch panel installation on back or front rack profile
- Panel available in rotating left or right side of patch panel (depends on version)
- Possibilities of termination cables on side or back of patch panel
- Hinged flap of patch panel protects patchcords from damages
- 2U and 3U patch panels can be combined with RT-01 tube divider

TECHNICAL SPECIFICATION	PSR-B0-01 / PSR-B0-B1	PSR-B0-02 / PSR-B0-B2	PSR-B0-03 / PSR-B0-B3
Dimensions: Height [U] x Width [inch] x Depth [mm]	1U x 19" x 315	2U x 19" x 315	3U x 19" x 315
Max. number of fibers	48	96	144
Max. number of splices	48	96	144
Max. number of splice trays	4	8	12
Max. line cable diameter [mm]	12	12	12
Casing material	powder painted steel		



View of 1U patch panel



View of 2U patch panel



View of 3U patch panel

VARIANT

FIBRAIN fiber pivot swivel patch panel 1U 19", leftt-sided, equipped in 4 x SCM-C-12H splice trays

FIBRAIN fiber pivot swivel patch panel 2U 19", left-sided, equipped in 8 x SCM-C-12H splice trays

FIBRAIN fiber pivot swivel patch panel 3U 19", left-sided, equipped in 12 x SCM-C-12H splice trays

REFERENCE NO.

PSR-B0-01-L-041-00000-0000000-000

PSR-B0-02-L-081-00000-0000000-000

PSR-B0-03-L-121-00000-0000000-000



# **03. 19" Cable shelves and organizers**

The logo for FIBRAIN, featuring the brand name in white uppercase letters on a red rectangular background, followed by a stylized icon of three horizontal bars of varying lengths.

FIBRAIN®

# Organise your cables in cabinet

A close-up photograph of a network cabinet's interior. Several thick, yellow, braided cables are bundled together and held in place by red plastic organizers. The organizers are curved and have the word 'FIBRAIN' embossed on them. The background is dark, highlighting the vibrant yellow and red colors of the cables and organizers.

We are pleased to announce that we have completed work on new organizers of crossover cables and patchcords, dedicated to distribution rack cabinets. Patchcord organizers are key elements of managing crossover cables or patchcords run between copper or fiber optic equipment mounted in distribution cabinets. They ensure the maintenance of order and full transparency, and also enable proper air circulation.

# 19" Cable shelves and organizers

## FIBRAIN ORG-HP-1U-B-V2 vertical organiser



- Mounted on a rack profile
- 1U height
- Ergonomic lockable handle
- Handle can be rotated in four positions

ORG-HP-1U-B-V2-S

VARIANT

REFERENCE NO.

FIBRAIN 1U vertical cable organizer with lockable handle, black

ORG-HP-1U-B-V2

FIBRAIN 1U vertical cable organizer with lockable handle, short version, black

ORG-HP-1U-B-V2-S

## FIBRAIN ORG-VP-1U-B-V2 Horizontal cable organizer



- 19" standard mounting
- 1U height
- 4 ergonomic lockable handles
- Can be applied along with vertical cable organiser

VARIANT

REFERENCE NO.

FIBRAIN horizontal cable organizer 1U 19"- with lockable handles, black

ORG-VP-1U-B-V2

# 19" Cable shelves and organizers

## FIBRAIN ORG-HS Vertical side cable organizer



- Height: 1U, 4U, 6U, 15U
- Backplate made of powder painted steel
- Guarantee optimum cable arrangement
- Equipped with easily opened-handle
- Left or right-hand installation



ORG-HS 1U



ORG-HS 4U



ORG-HS 6U



ORG-HS 15U

VARIANT

REFERENCE NO.

FIBRAIN 19" vertical side cable organizer with easily-opened plastic handles, 1U

ORG-HS-1U-B

FIBRAIN 19" vertical side cable organizer with easily-opened plastic handles, 4U

ORG-HS-4U-B

FIBRAIN 19" vertical side cable organizer with easily-opened plastic handles, 6U

ORG-HS-6U-B

FIBRAIN 19" vertical side cable organizer with easily-opened plastic handles, 15U

ORG-HS-15U-B

# 19" Cable shelves and organizers

## Patchcord organiser for PST-A patch panel

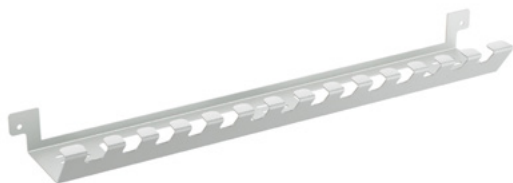

- Mounting on the front panel of PST-A 1U patch panel
- Easy access and organisation of cables
- Optional velcro tapes

### TECHNICAL SPECIFICATION

Dimensions: Height [mm] x Width [inch] x Depth [mm]	35 x 19" (482,6 mm) x 77
Material	Powder painted steel

### VARIANT

### REFERENCE NO.

FIBRAIN patchcords management shelf for 1U PST-A	FB2030G.V2
FIBRAIN patchcords management shelf for 1U PST-A with velcro tape	FB2030G.V2P

## FIBRAIN PS-ORG-1-PP Horizontal cable organizer



- Height 1U
- Width 19"
- Easy patchcord's organization
- Detachable handles facilitating cables placement

### TECHNICAL SPECIFICATION

Dimensions: Height [U] x Width [inch] x Depth [mm]	1U (U=44 mm) x 19" (482,6 mm) x 65
Material	Powder painted steel + ABS

### VARIANT

### REFERENCE NO.

19" Horizontal fiber optic cable organizer	PS-ORG-1-PP
--	-------------



# 19" Cable shelves and organizers

## PS-19-1-TUB Tube reserve shelf



- Full extension on telescopic rails
- Easy access to collected fiber optic tubes
- Lockable front panel
- Possibility to install 2 pieces of PS-TH-12-5 tube holders

### TECHNICAL SPECIFICATION

Dimensions: Height [U] x Width [inch] x Depth [mm]	1U (U=44 mm) x 19" (482,6 mm) x 258
Material	Powder painted steel



View of 1U 19" tubes reserve shelf

### VARIANT

FIBRAIN 1U 19" tubes reserve shelf

### REFERENCE NO.

PS-19-1-TUB

# 19" Cable shelves and organizers

## PS-19-1-PAT Patchcords reserve shelf



- Height 1U
- Full extension on telescopic rails
- Easy access to collected patchcords
- Front panel equipped with organiser and velcro tapes to attach patchcords

### TECHNICAL SPECIFICATION

Dimensions: Height [U] x Width [inch] x Depth [mm]	1U (U=44 mm) x 19" (482,6 mm) x 258
Material	Powder painted steel



[View PS-19-1-PAT](#)

### VARIANT

FIBRAIN patchcords reserve shelf 1U 19"

### REFERENCE NO.

PS-19-1-PAT

# 04. Boxes and cabinets

# EAC

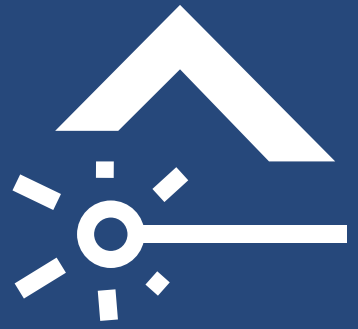

**Easy Access Cable** System is a complete fiber optic solution for a multi-storey building using EAC cables.

A special design gives the possibility to easy access cables by cutting a hole in the outer sheath without the need to connect at the branching point. This method permits removing a fiber optic module at the distance of 25 m and, depending on the installation method, place a cable to the

customer outlet. The system is complemented by specifically designed tools, equipment and the possibility of ordering a pre-connectorized EAC cable, allowing easy and quick preparation of the whole network in a building.

## EAC system advantages

- Fast and flexible method of connecting users in multi-storey buildings
- Optimization of the workforce, cost and installation time
- Direct branching to subscribers without performing splices
- Flexible system that can be easily developed in the future
- Customization of cables and equipment to minimise the costs
- Support team from Design Department throughout the whole investment

Product center → [www.fibrain.com](http://www.fibrain.com)

# EAC system elements

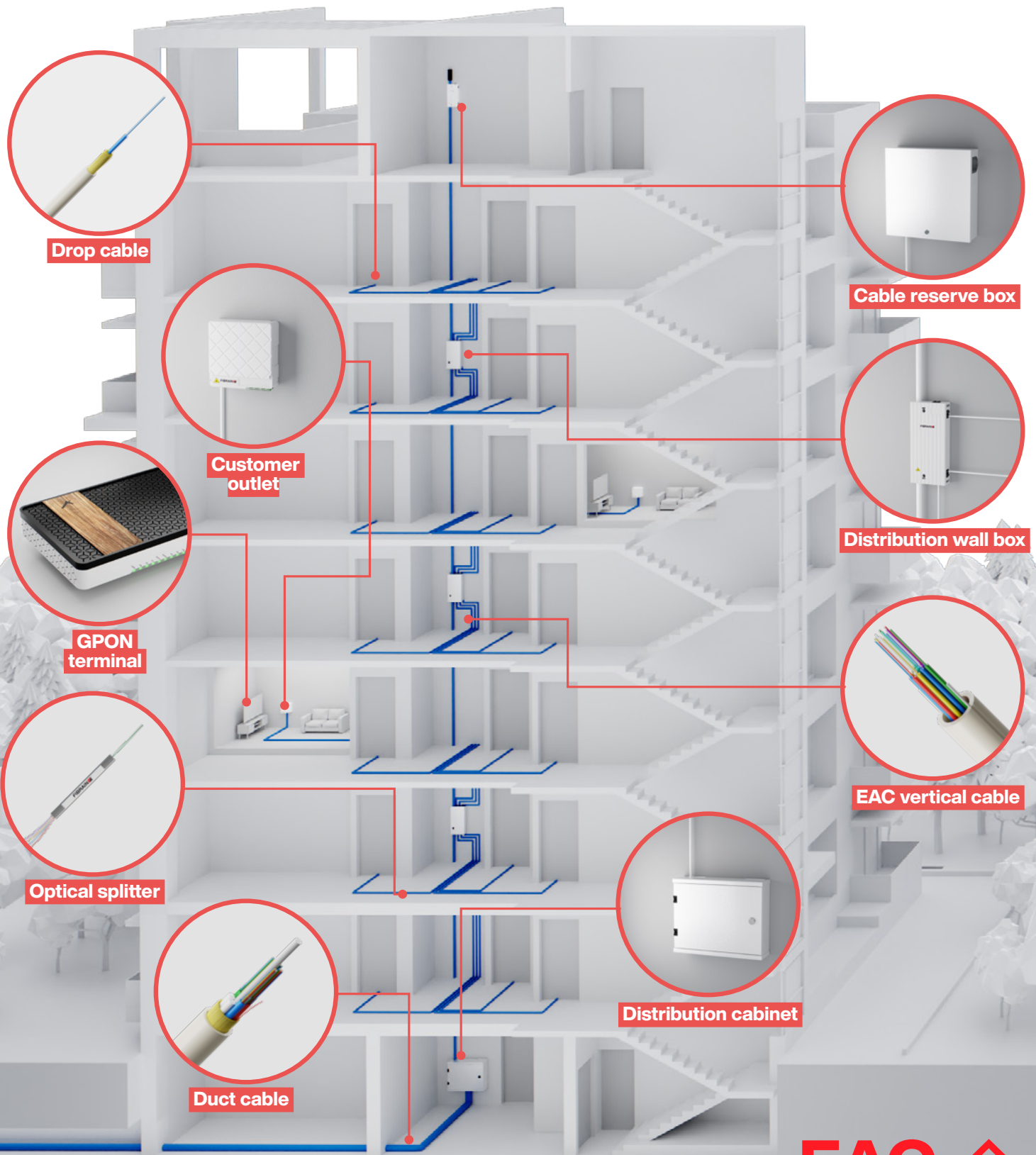

# Boxes and cabinets

## FIBRAIN VFTO-E1 Customer outlet



- Up to 2 pieces of SC SX/ LC DX adapters
- Holder for 4 splices
- Description field for adapters on a top part of an outlet with a transparent flip cover
- Possibility to personalize the outlet (logo, website, helpdesk phone number)
- Optional adapter for DIN rail
- Optional wall support

### TECHNICAL SPECIFICATION

Adapter type	Flangeless (SC simplex, LC duplex)
Material	ABS UL94-V0
Adapter material DIN	PA6 GF UL94-V0
Dimensions: Height x Width x Depth [mm]	72 x 160 x 29
Temperature range [C°]	-20 to +50
Protection level	IP40/IK06



Inside view of the outlet



A-E1 subscriber set with cable reel

### VARIANT

### REFERENCE NO.

FIBRAIN VFTO-E1 outlet without logo, not equipped	VFTO-E1-BL-0
FIBRAIN VFTO-E1 outlet with FIBRAIN logo, not equipped	VFTO-E1-FB-0
FIBRAIN VFTO-E1 outlet with FIBRAIN logo equipped in 2 x SC APC adapters	VFTO-E1-FB-0-212-000
FIBRAIN VFTO-E1 outlet with FIBRAIN logo equipped in 2 x SC APC adapters, 2x pigtails G657A1	VFTO-E1-FB-0-212-2DG



# Boxes and cabinets

## FIBRAIN VFTO-F1 Customer outlet



- Up to 4 adapters
- Holder for 8 splices
- Cable entrance from each side of the box
- Possibility to personalize the outlet (logo, website, helpdesk phone number)

### TECHNICAL SPECIFICATION

Adapter type	SC simplex, LC duplex
Material	PC ABS
Dimensions (w)x(h)x(d) [mm]:	100x80x28
Protection level:	IP45
Mounting:	Wall mounting, accessory and splice protectors included



### VARIANT

### REFERENCE NO.

FIBRAIN VFTO-F1 customer outlet for 4 adapters, without logo, not equipped	VFTO-F1-BL-0
FIBRAIN VFTO-F1 customer outlet for 4 adapters, FIBRAIN logo, not equipped	VFTO-F1-FB-0

# Boxes and cabinets

## FIBRAIN DIN module FDM-S



- Capacity up to 24 splices
- Can be easily snapped on a DIN-Rail 35 mm
- Cable entries from the top and bottom
- Possibility to mount up to 24 x SC SX / LC DX / FC/ST and 2 x MTP fiber optic adapter

TECHNICAL SPECIFICATION	FDM-S19	FDM S11, S12, S15, S16	FDM S13, S14, S17, S18
Dimensions: Height x Width x Depth [mm]	35 x 135 x 130	35 x 200 x 130	66 x 200 x 130
Max. number of splices	12	12	24
Max. number of SC SX / LC DX adapter	08	12	24
Max. number of ST / FC adapter	0	12	24
Max. number of MTP adapter	0	1	2
Cable gland qty/type	2/PG13.5	2/PG13.5	4/PG13.5
Material	aluminium		



View of internal part of the FDM Module



View of FDM Module with 24 x SC SX and 2 x MTP adapters

### VARIANT

### REFERENCE NO.

FIBRAIN DIN module with panel 12 SC SX + MTP, equipped with 2 cable gland 13.5	FDM-S11-000000-000000-000-11
FIBRAIN DIN module with panel 24 SC SX + 2 X MTP, equipped with 2 cable gland 13.5	FDM-S13-000000-000000-000-11
FIBRAIN DIN module equipped 12 panel type SC SX , 2 cable gland 13.5	FDM-S15-000000-000000-000-11
FIBRAIN DIN module with panel 24-SC-SX	FDM-S17-000000-000000-000-00
FIBRAIN DIN module with panel 8 SC SX, equipped with 2 cable gland 13.5	FDM-S19-000000-000000-000-11

# BU-XN

FIBRAIN wall-mounted fiber optic box



PATENT PENDING

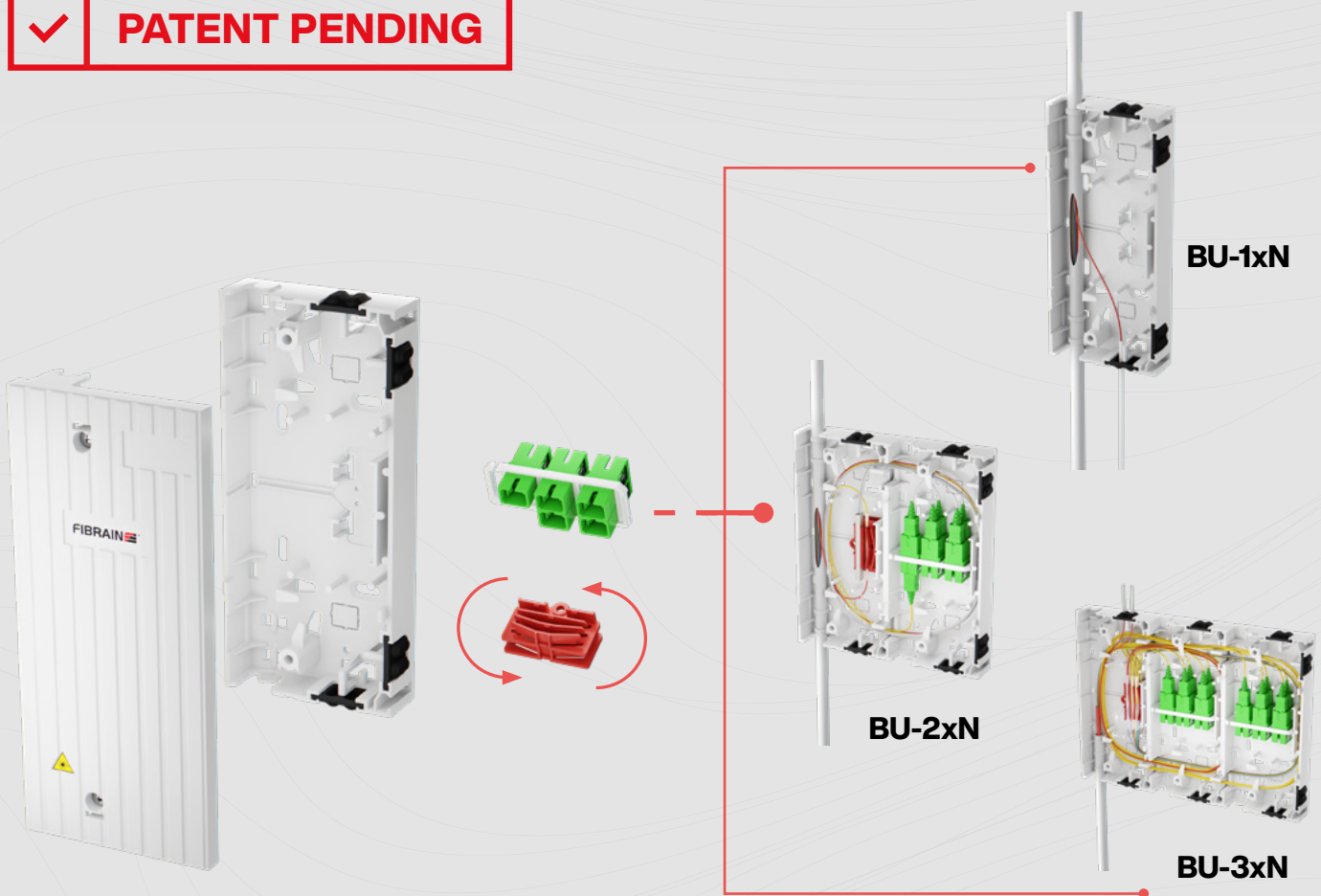

One product –  
many possibilities.

# Boxes and cabinets

Distribution boxes provide in-line cable installation and fiber branching in various directions. Fiber optic transmission to end users is guaranteed by a spliced connection, patchcord or an optical fiber extracted from the EAC cable.

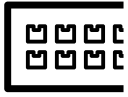

**Adapter panel**

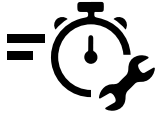

**Quick installation**

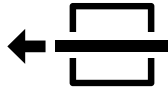

**In-line cable installation**



**Light plastic housing**

## Can be used as:

- cable protection cover for protecting the window cut
- breakout unit for distribute the fiber from vertical EAC cable to a customer premise
- Wall mounted cabinet for spliced connection
- Wall mounted cabinet with adapter panel

## BU-XN Examples of applications

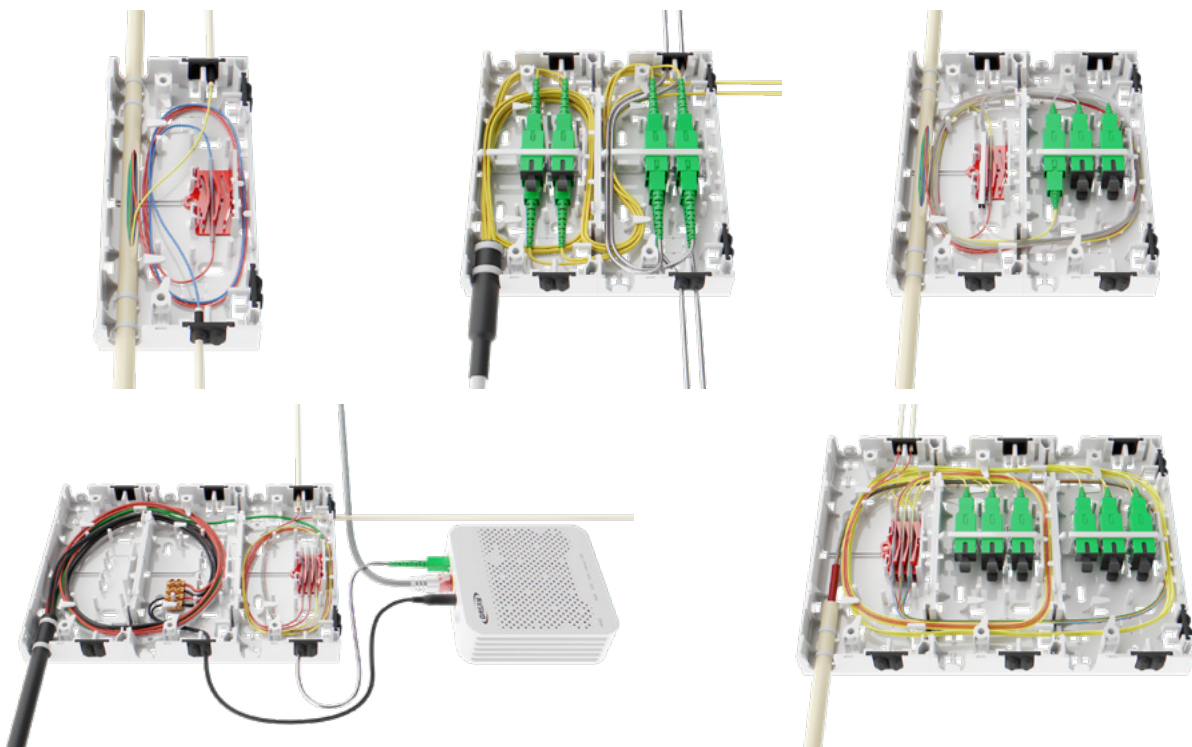

# Boxes and cabinets

## BU-XN wall-mounted fiber optic box



- Housing material PC+ABS – ensures high mechanical resistance
- Light and compact design
- Optional splice holders for 6 splices
- Optional panel for 5 adapters
- Possibility of mounting 3 Alubox 55 x 7 x 4 mm PLC splitters in splice holder
- Dedicated mounting points for inline and drop cable
- Possibility of installation up to 8 drop cables
- Max. 2 splice holders per box



### TECHNICAL SPECIFICATION:

Max. splices number	12
Max. adapters number	5
FO adapter type (flangeless only)	SC, LC
Max. cable diameter:	
- inline cable port	Ø 15 mm
- drop cable port	Ø 5 mm
Dimensions: Height x Width x Depth [mm]	72 x 160 x 29
Temperature range [C°]	-20 to +50
Housing material	PC + ABS
Splice holder material	PP
Adapter panel material	PC + ABS
Ingress protection	IP44

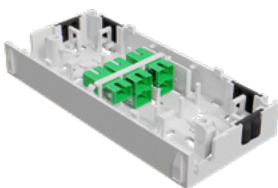

View of housing equipped in adapter panel and SCA adapters

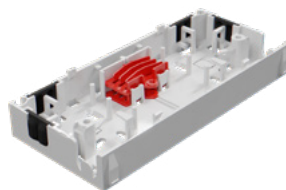

View of housing equipped in splice holder

# Boxes and cabinets

## BU-XN wall-mounted fiber optic box

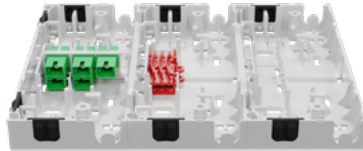
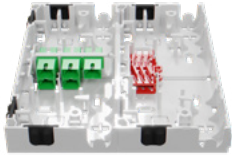

VARIANT

REFERENCE NO.

FIBRAIN wall box BU-XN

BU-XN-0000-000-WH

FIBRAIN wall box BU-XN equipped 2 splice holder

BU-XN-0000-200-WH

FIBRAIN wall box BU-XN equipped adapter panel, 5 adapters SC APC standard

BU-XN-1512-000-WH



# Wall mounted distribution indoor cabinets



**Solid. Thoroughly tested. Made in Poland.**

Topology of fiber network also provides the installation of fiber optic cable ends in wall cabinets that are solutions specifically designed for mounting directly indoor.

Quite often, these are low- fiber capacity solutions and used anywhere where there is no possibility or purpose of mounting rack cabinet. Therefore, this type of solutions are frequently used in FTTx networks.



# Boxes and cabinets

## NSR wall mounted distribution cabinet



- Available in three different sizes
- Splice capacity from 24 up to 96
- Adapter panel for SC SX, SC DX, ST, FC
- Door protection with cylindrical lock
- Cable entry sealed with foam or cable glands depending on the cabinet type

TECHNICAL SPECIFICATION	NSR-S-xx	NSR-M-xx	NSR-L-xx
Dimensions: Height x Width x Depth [mm]	304 x 150 x 55	325 x 285 x 55	445 x 445 x 100
Max. number of splices	24	72	96
Max. number of adapters	12	24	72
Max. number of entry cables	4	6	6
Cable gland qty	-	-	4
Cable gland type	-	-	PG 13,5
Color	Grey RAL 7035	Grey RAL 7035	Grey RAL 7035
Material	Powder painted steel	Powder painted steel	Powder painted steel



NSR-S



NSR-M



NSR-L

## VARIANT

## REFERENCE NO.

NSR-S distribution wall mounted cabinet equipped in 12xSC adapter panel and 1 splice cassette SCM-A-24H

NSR-S-14-00000-00000000-12-000-00

NSR-M distribution wall mounted cabinet equipped in 24xSC adapter panel and 1 splice cassette SCM-A-24H

NSR-M-07-00000-00000000-12-000-00

NSR-L distribution wall mounted cabinet equipped in 72xSC adapter panel and 3 splice cassette SCM-A-24H

NSR-L-12-00000-00000000-32-000-00

# Boxes and cabinets

## FIBRAIN IFDT-B0 wall mounted distribution box



- Max. capacity of 48 SC adapters
- Two-section design- line cable and subscriber
- Prepared to install splitters, cables and micropipes
- Holder for identification card
- Cable central member holder
- Cabinet sections secured with lock
- Optional cable reserve frame
- Mounting the cabinet with a use of nail expansion anchors

### TECHNICAL SPECIFICATION

Max. splice quantity	48
Max. adapter quantity	48
Max. cable diameter [mm]	18,6
Dimensions: Height x Width x Depth [mm]	390 x 315 x 110 (175)*
Material	Powder painted steel

\*cabinet depth with cable reserve frame installed



Subscriber section

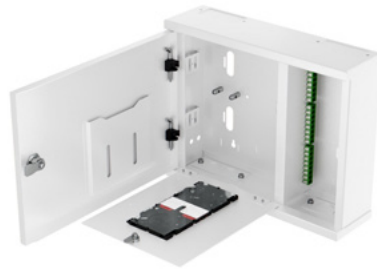

View of line cable part



View of cabinet equipped in cable reserve frame

### VARIANT

FIBRAIN IFDT-B0 fiber distribution terminal equipped in 48 adapters, 2 splice trays 24h

FIBRAIN IFDT-B0 fiber distribution terminal equipped in 48 adapters, 2 splice trays 24h, cable reserve frame

### REFERENCE NO.

IFDT-B00-48-000-22

IFDT-B0Z-48-000-22

# Boxes and cabinets

## FIBRAIN IFDT-C0 wall mounted distribution box



- Capacity max. 48 splices
- Prepared to install splitters, cables and micropipes
- Holder for identification card
- Cable central member holder
- Cabinet door secured with lock
- Optional cable reserve frame
- Mounting the cabinet with a use of nail expansion anchors

### TECHNICAL SPECIFICATION

Max. splice quantity	48
Max. cable diameter [mm]	18,6
Dimensions: Height x Width x Depth [mm]	270 x 315 x 110 (175)*
Material	Powder painted steel

\*cabinet depth with cable reserve frame installed



Inside view of cabinet



Optional cable reserve frame mounted on the rear part of the cabinet

### VARIANT

FIBRAIN cabinet IFDT version C0 equipped with 2 cassettes of 24 welds

FIBRAIN cabinet IFDT version C0 equipped with 2 cassettes of 24 welds, cable stock frame

### REFERENCE NO.

IFDT-C00-22-0000-0

IFDT-C0Z-22-0000-0

# Boxes and cabinets

## FIBRAIN IFDT-F0 wall mounted distribution box



- Adapter panel for 48 x SC SX / LC DX adapters
- Maximum 96 splice capacity
- 8 cable ports for maximum diameter Ø32 mm
- Holder for Alubox and Blackbox splitters
- Cable central member holder
- Cabinet secured with lock
- SCM-A splice cassettes
- Mounting the cabinet with a use of nail expansion anchors

### TECHNICAL SPECIFICATION

Max. splice quantity	96
Max. adapter quantity	48
Max. cable diameter [mm]	32
Dimensions: Height x Width x Depth [mm]	400 x 370 x 110
Material	Powder painted steel



Inside view of cabinet

### VARIANT

### REFERENCE NO.

FIBRAIN wall mounted distribution box with panel for 48 adapters, equipped in 2 x SCM-A-24H splice cassettes

IFDT-F0-0000-22

FIBRAIN wall mounted distribution box with panel for 48 adapters, equipped in 48 x SC APC SX adapters, 2 x SCM-A-24H splice cassettes

IFDT-F0-4812-22

# Boxes and cabinets

## FIBRAIN IFDT-G0-x wall mounted distribution box



- Adapter panel for 48 x SC SX / LC DX adapters
- Maximum 96 splice capacity
- 6 cable ports for maximum diameter Ø32mm
- Uncut cable installation possible (special cable port with split cable glands)
- Cable tube organizer
- SCM-C splice cassettes
- Double section cabinet secured with lock

### TECHNICAL SPECIFICATION

Max. splice quantity	96
Max. adapter quantity	48
Max. cable diameter [mm]	32
Dimensions: Height x Width x Depth [mm]	440x390x135
Material	Powder painted steel



Inside view of cabinet

### VARIANT

### REFERENCE NO.

FIBRAIN wall mounted distribution cabinet with panel for 48 adapters, equipped in 4x SCM-C splice cassettes

IFDT-G0-4

FIBRAIN wall mounted distribution cabinet with panel for 48 adapters, equipped in 4x SCM-C splice cassettes, 48x SCA adapters

IFDT-G0-4-48121

FIBRAIN wall mounted distribution cabinet with panel for 48 adapters, equipped in 4x SCM-C splice cassettes, 48x SCA adapters, 48x SCA G657A1 pigtails

IFDT-G0-4-48121-48D02G01



**05.**

**Accessory**

# Accessory

## SCM-C splice tray

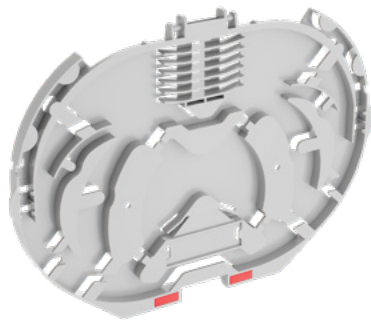

- Capacity up to max. 12 splices
- Possibility of changing a fiber direction
- Labeling field
- Easy identification of a cassette with the use of colorful icons
- Possibility of mounting splitter in Alubox housing
- Optional cover
- Splice holder fits OD 2,4 mm protection sleeves

### TECHNICAL SPECIFICATION

Dimensions: Length x Width x Height [mm]	148 x 109 x 5,5
Capacity	max. 12 splices

### VARIANT

### REFERENCE NO.

FIBRAIN oval splice cassette with build-in handle for 12 heat shrink protection sleeves and possibility to mount Alubox optical splitter, white	SCM-C-12H-GY
FIBRAIN oval splice cassette with build-in handle for 12 heat shrink protection sleeves and possibility to mount Alubox optical splitter, white with cover	SCM-C-12H-GY-C
FIBRAIN oval splice cassette with build-in handle for 12 heat shrink protection sleeves and possibility to mount Alubox optical splitter, white – 20 pcs set (without icons)	SCM-C-12H-GY-SET20

# Accessory

## ID-ICON-SET12 Identification icons



- The set consists of 144 icons in 12 colours: red, green, blue, white, purple, orange, gray, yellow, brown, pink, black, turquoise (12 icons per color)
- Easy identification of cassettes and optical fibers / tubes
- Fast assembly requiring no tools
- Compatible with SCM-A and SCM-C splice cassettes

### TECHNICAL SPECIFICATION

Dimensions: Length x Width x Height [mm]	9,9 x 3,4 x 1,2
Material	PP

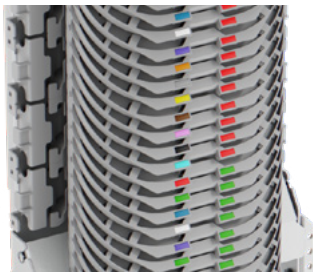

Example of application of identification icons on FOBP closure

### VARIANT

FIBRAIN identification icons, 12 colours – 144 pcs set

### REFERENCE NO.

ID-ICON-SET12

# Accessory

## Heat-shrink splice protection sleeve, FB744x



- Transparent sleeve
- Fulfills the requirements of UL224, MIL-I-23053, GR-1380-CORE, ZN-96 TPSA-006 standards
- In accordance with RoHS Directive
- Min. shrink temperature: 110°C
- Max. shrink time: 60s

TECHNICAL SPECIFICATION	FB7442	FB7443
L - Sleeve length after heating	45	61
Lp - Pin length	41	57
D - Sleeve diameter after heating	2,4	2,8
Dp - Pin diameter	1	1
d - Inner hole diameter before shrink	1,4	1,4

VARIANT	REFERENCE NO.
Heat-shrink splice protection sleeve 45 mm	FB7442
Heat-shrink splice protection sleeve 61 mm	FB7443

# Accessory

## SCM-A Splice cassette

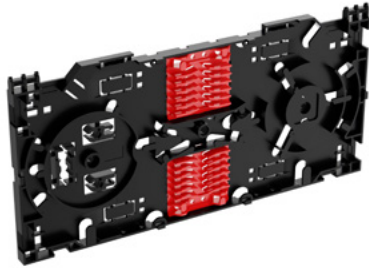

- Capacity up to 24 splices
- Exchangeable handles for splices
- Labeling field
- Possibility of stacking the cassettes with built-in hinges
- Possibility of changing the direction of a fiber
- Possibility of placing a fiber from a bottom side of the cassette
- Easy identification of a cassette with the use of colorful icons
- Possibility of mounting splitters in Alubox housing
- Equipped with transparent cover
- Splice holder fits OD 2,4 mm protection sleeves

### TECHNICAL SPECIFICATION

Dimensions: Length x Width x Thickness [mm]	195 x 93,6 x 8,9
Capacity	24 splices
Material	PC + ABS



SCM-A-12H Cassette with an option for 12 fusion splices and 2 splitters

VARIANT	REFERENCE NO.
FIBRAIN splice cassette with a handle for 12 heat shrink splice protection sleeves	SCM-A-12H
FIBRAIN splice cassette with a handle for 24 heat shrink splice protection sleeves	SCM-A-24H
FIBRAIN splice cassette with a handle for 12 heat shrink splice protection sleeves – 30 pcs set (without icons)	SCM-A-12H-SET30
FIBRAIN splice cassette with a handle for 24 heat shrink splice protection sleeves – 30 pcs set (without icons)	SCM-A-24H-SET30

# Accessory

## RT-01 Tube divider



- Capacity up to 24 fiber optic tubes
- Cable central member holder
- Available for Ø5 mm or Ø10 mm tubes
- Can be mounted on RT-L8-01-19 or PSR patch panels
- Equipped in cable steel band and cable gland

TECHNICAL SPECIFICATION	RT-01-0310	RT-01-1205	RT-01-2405
Max. number of cable tubes	3	12	24
Max. number of protective pipe	3	12	24
Max. diameter of protective pipe [mm]	10	5	5
Max. diameter of fiber optic cable [mm]	14	14	18
Max. number of cable tube divider installed on distribution frame	8	8	4
Dimensions: Length x Width x Height [mm] (no cable gland)	68* x 46 x 123 *(with mounting)	68* x 46 x 123 *(with mounting)	122* x 53 x 162,5 *(with mounting)
Operating temperature [°C]	-20 to +50	-20 to +50	-20 to +50
Type of housing material	powder painted steel		

### ADDITIONAL EQUIPMENT

#### Elements

Distribution frame for mounting RT-01-xx	RT-L8-01-19
Protective pipe 5 mm	OFPT-5.0-3.1-PP-WHT
Protective pipe 10 mm	OR3F-MYDSN-10-10

### VARIANT

### REFERENCE NO.

FIBRAIN cable tube divider equipped for mounting 3 protective pipes 10 mm	RT-01-0310
FIBRAIN cable tube divider equipped for mounting 12 protective pipes 5 mm	RT-01-1205
FIBRAIN cable tube divider equipped for mounting 24 protective pipes 5 mm	RT-01-2405



# 06. Outdoor cabinets

**FIBRAIN** 

# Outdoor cabinets

## FTTH Solutions

Distribution cabinets are specifically designed as a distribution point inside a building for optical fibers installed with the use of EAC and FTTH systems. Preconnectorized connections and fiber splicing can be performed inside.



Up to  
153 SC adapters

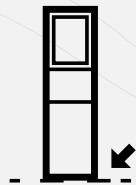

Ground  
mounting



Fiber glass  
+ polyester



Lock  
secured



IP54 waterproof  
protection

# Outdoor cabinets

## FIBRAIN outdoor fiber optic cabinet FDH-E1



- Removable internal organizer made of galvanized steel
- Dedicated holders for cables / microducts entering the cabinet
- Max. capacity up to 96 splices
- Adapter panel for 13 SC adapters
- Possibility of mounting 3 splitters in Blackbox / Alubox housing
- Possibility of storage up to 5m of cable stock
- Optional separating plate with 3 cable membranes
- Optional lock for front door

### TECHNICAL SPECIFICATION

Adapter type	SC, LC DX
Max. number of splitters (Blackbox, Alubox)	3
Dimensions: Height x Width x Depth [mm]	400 x 1416 x 266
Front door dimensions [mm]	456 x 400
Cabinet height above the ground	756
Flammability class	V0
Internal organizer material	Galvanized steel
Housing material	Fiber glass + polyester



Internal view



Removable organizer

### VARIANT

FIBRAIN outdoor fiber optic cabinet FDH-E1 equipped in 13 adapters SCA Standard class, 4 splice cassettes SCM-A-24H, expanded clay, lock, grey colour

### REFERENCE NO.

FDH-E1-1312-0000000-000-42-0-1-1-GY

# Outdoor cabinets

## FIBRAIN outdoor fiber optic cabinet FDH-E2



- Removable internal organizer made of galvanized steel
- Dedicated holders for cables / microducts entering the cabinet
- Max. capacity up to 120 splices
- Adapter panel for 39 SC adapters
- Possibility of mounting 3 splitters in Blackbox / Alubox housing
- Possibility of storage up to 5m of cable stock
- Optional separating plate with 3 cable membranes
- Optional lock for front door

### TECHNICAL SPECIFICATION

Adapter type	SC, LC DX
Max. number of splitters (Blackbox, Alubox)	3
Dimensions: Height x Width x Depth [mm]	400 x 1416 x 266
Front door dimensions [mm]	456 x 400
Cabinet height above the ground	756
Flammability class	V0
Internal organizer material	Galvanized steel
Housing material	Fiber glass + polyester



Internal view

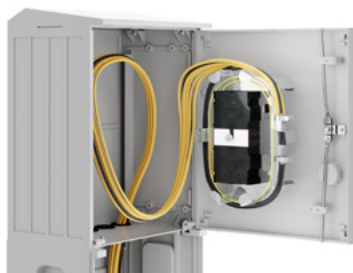

Removable organizer

### VARIANT

FIBRAIN outdoor fiber optic cabinet FDH-E2 equipped in 39 adapters SCA Standard class, 5 splice cassettes SCM-A-24H, expanded clay, lock, grey colour

### REFERENCE NO.

FDH-E2-3912-0000000-000-52-0-1-1-GY

# Outdoor cabinets

## FIBRAIN outdoor fiber optic cabinet FDH-G1



- Hinged plate with adapter panel
- Dedicated holders for cables / microducts entering the cabinet
- Maximum capacity of 72 splices
- Adapter panel for 27 SC adapters
- Possibility of mounting 3 splitters in Blackbox / Alubox housing
- Possibility of storage up to 5m of cable stock
- Optional lock for front door
- Door open at an angle of 180°

### TECHNICAL SPECIFICATION

Adapter type	SC, LC DX
Max. number of splitters (Blackbox, Alubox)	3
Dimensions: Height x Width x Depth [mm]	260 x 1416 x 266
Front door dimensions [mm]	260 x 472
Cabinet height above the ground	756
Flammability class	V0
Internal organizer material	Powder painted steel
Housing material	Fiber glass + polyester



Internal view



Removable organizer

### VARIANT

### REFERENCE NO.

FIBRAIN FDH-G1 outdoor cabinet, equipped in look

FDH-G1-10

FIBRAIN FDH-G1 outdoor cabinet, equipped in look, LEICA, 2 x SCM-A-24H splice cassette

FDH-G1-11-22

FIBRAIN FDH-G1 outdoor cabinet, equipped in look, LEICA, 2 x SCM-A-24H splice cassette, 27 X SC APC adapter

FDH-G1-11-22-2712

# Outdoor cabinets

## FIBRAIN outdoor fiber optic cabinet FDH-G2



- Hinged plate with adapter panel
- Dedicated holders for cables / microducts entering the cabinet
- Maximum capacity of 96 splices
- Adapter panel for 48 SC adapters
- Possibility of mounting 3 splitters in Blackbox / Alubox housing
- Possibility of storage up to 5m of cable stock
- Optional lock for front door
- Door open at an angle of 180°

### TECHNICAL SPECIFICATION

Adapter type	SC, LC DX
Max. number of splitters (Blackbox, Alubox)	4
Dimensions: Height x Width x Depth [mm]	400 x 1416 x 266
Front door dimensions [mm]	400 x 472
Cabinet height above the ground	756
Flammability class	V0
Internal organizer material	Powder painted steel
Housing material	Fiber glass + polyester



Internal view



Removable organizer

### VARIANT

### REFERENCE NO.

FIBRAIN FDH-G2 outdoor cabinet, equipped in lock	FDH-G2-10
FIBRAIN FDH-G2 outdoor cabinet, equipped in lock, LEICA, 4 x SCM-A-24H splice cassette	FDH-G2-11-42
FIBRAIN FDH-G2 outdoor cabinet, equipped in lock, LEICA, 2 x SCM-A-24H splice cassette, 48 X SC APC adapter	FDH-G2-11-22-4812

# Outdoor cabinets

## FIBRAIN outdoor fiber optic cabinet FDH-G3



- Hinged plate with adapter panel
- Dedicated holders for cables / microducts entering the cabinet
- Maximum capacity of 96 splices
- Adapter panel for 96 SC adapters
- Possibility of mounting 3 splitters in Blackbox / Alubox housing
- Possibility of storage up to 5m of cable stock
- Optional lock for front door
- Door open at an angle of 180°

### TECHNICAL SPECIFICATION

Adapter type	SC, LC DX
Max. number of splitters (Blackbox, Alubox)	3
Dimensions: Height x Width x Depth [mm]	400 x 1516 x 266
Front door dimensions [mm]	400 x 556
Cabinet height above the ground	856
Flammability class	V0
Internal organizer material	Powder painted steel
Housing material	Fiber glass + polyester



Internal view



Removable organizer

### VARIANT

### REFERENCE NO.

FIBRAIN FDH-G3 outdoor cabinet, equipped in look	FDH-G3-10
FIBRAIN FDH-G3 outdoor cabinet, equipped in look, LEICA, 2 x SCM-A-24H splice cassette	FDH-G3-11-42
FIBRAIN FDH-G3 outdoor cabinet, equipped in look, LEICA, 2 x SCM-A-24H splice cassette, 48 X SC APC adapter	FDH-G3-11-42-9612



# Outdoor cabinets

## FIBRAIN outdoor fiber optic cabinet FDH-G4



- Hinged plate with adapter panel
- Dedicated holders for cables / microducts entering the cabinet
- Maximum capacity of 144 splices
- Adapter panel for 144 SC adapters
- Possibility of mounting 6 splitters in Blackbox / Alubox housing
- Possibility of storage up to 5m of cable stock
- Optional lock for front door
- Door open at an angle of 180°

### TECHNICAL SPECIFICATION

Adapter type	SC, LC DX
Max. number of splitters (Blackbox, Alubox)	6
Dimensions: Height x Width x Depth [mm]	400 x 1516 x 266
Front door dimensions [mm]	400 x 556
Cabinet height above the ground	856
Flammability class	V0
Internal organizer material	Powder painted steel
Housing material	Fiber glass + polyester



Internal view



Removable organizer

### VARIANT

### REFERENCE NO.

FIBRAIN FDH-G4 outdoor cabinet, equipped in lock	FDH-G4-10
FIBRAIN FDH-G4 outdoor cabinet, equipped in lock, LEICA, 6 x SCM-A-24H splice cassette	FDH-G4-11-62
FIBRAIN FDH-G4 outdoor cabinet, equipped in lock, LEICA, 6 x SCM-A-24H splice cassette, 144 X SC APC adapter	FDH-G4-11-62-14412

# **07. Closures and distribution boxes**

# The new version of **FOBP** fiber optic closure

✓ **PATENT PENDING**

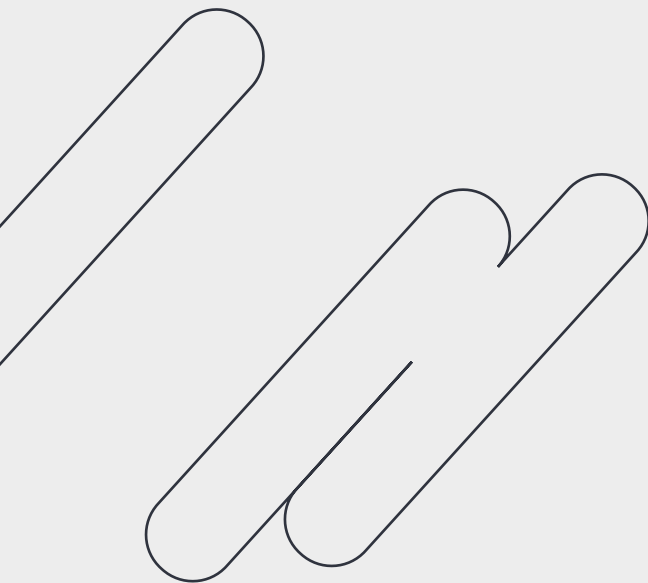

FIBRAIN fiber optic closures guarantee easy placement of core and drop cables with a possibility of preconnectorized cables, organizing tubes, splitters, adapters as well as protecting fibers in further exploitation.

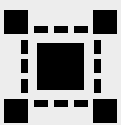

Max. 288  
splices



Cable diameter  
3 - 20 mm



Max. 18 adapter  
fields



Solid  
construction



Modularity



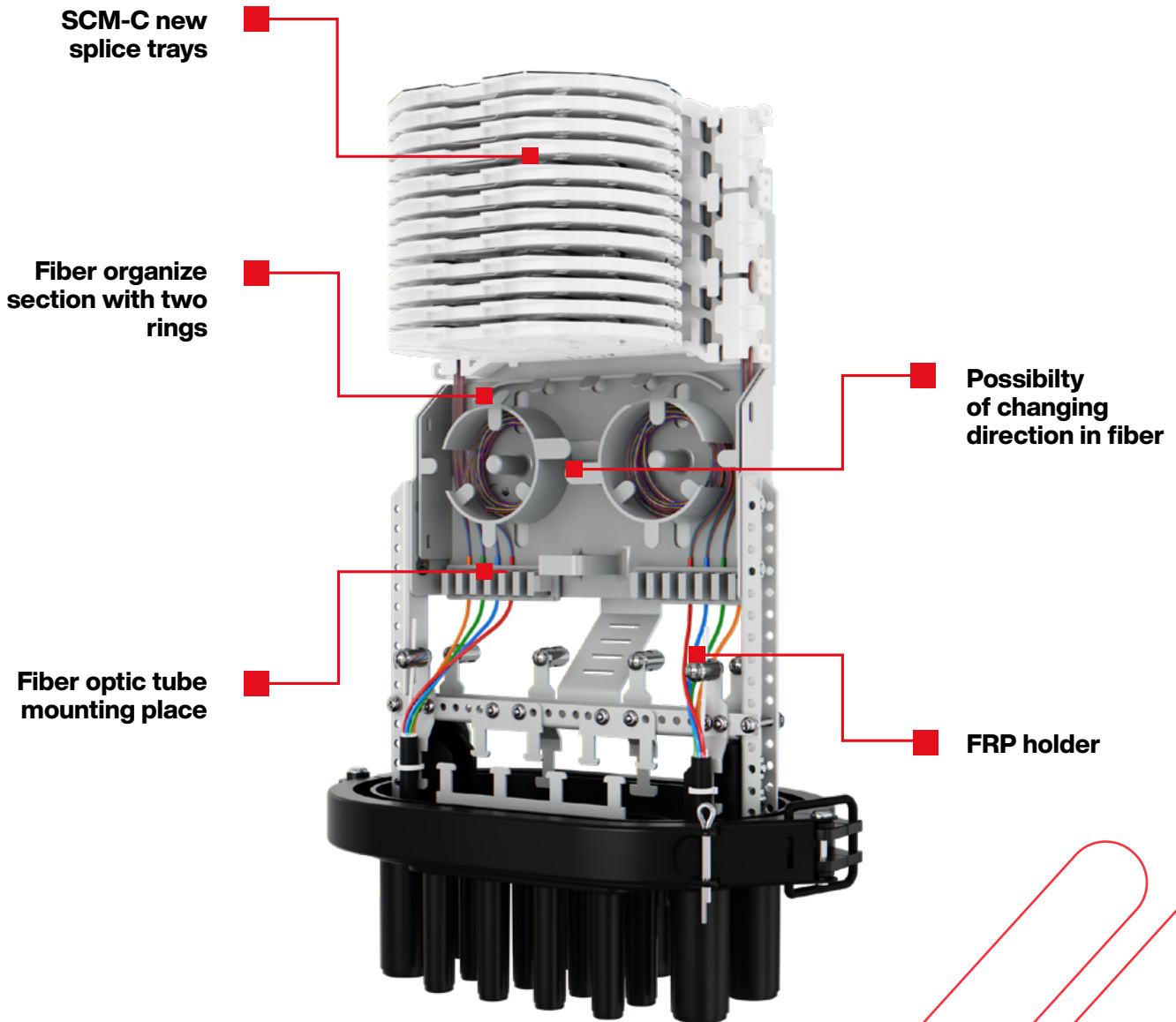

# **MOUNTING NUMEROUS COMPONENTS ON-SITE**

Following market trends, installers' requirements and the Max. functionality of our products, we offer you a new variant of FOBP-R fiber optic closure equipped with fibers organizer. The new

version gives additional possibilities to organize fibers, make connections and store extra length of fibers.

→ [www.fobp.fibrain.pl](http://www.fobp.fibrain.pl)

# Closures and distribution boxes

## FIBRAIN FOBP-M fiber optic closure, thermo-mechanical type of ports seals



- Max. capacity 288 splices
- Thermic and mechanical type of port seals
- 2 cable glands with multiplication inserts, 4 round cable entry and 1 oval port for uncut cables
- Pole and wall mounting
- Optional adapter panel
- Possibility of mounting Alubox splitters
  - 1:4, 1:8 mounted in splice tray
  - 1:16 mounted in dedicated handle

✓ **PATENT PENDING**

TECHNICAL SPECIFICATION	FOBP-144	FOBP-288
Max. number of splices	144	288
Max. number of splice trays	12	24
Max. capacity of splice tray	12	12
Range of cable diameter for 2 mechanical ports	3 – 6 mm, 4,5 – 6,5 mm, 6 – 8 mm, 8 – 10 mm, flat: 8,3 x 4,6 mm, 2 – 20 mm	
Max. quantity of cable per one mechanic port	4 (insert: 3 – 6 mm, 6 – 8mm, 8 – 10 mm, flat: 8,3 x 4,6 mm) 6 (insert: 4,5 – 6,5 mm) X* (membrane type insert: 2 – 20 mm)	
Range of cable diameter for 4 round thermic ports [mm]	6 – 20	6 – 20
Range of cable diameter for a thermic oval port [mm]	8 – 25	8 – 25
Max. quantity of cable installed	17*	17*
Dimensions Width x Height x Depth [mm]	293 x 438 x 162	293 x 568 x 162
Leakproofness of ports	Mechanic and thermic	
Type of entrance cables	Duct cable, aerial cable	
Operation temperature [°C]	-40 to +70	-40 to +70
IP protection	IP68	IP68
Pull box compatibility:		
- min. chamber diameter [mm]	240	240
- minimum chamber Depth [mm]	350	350

\* while membrane type insert is used Max. number of cables depends on the diameter of the cable inserted

# Closures and distribution boxes

## FIBRAIN FOBP-M fiber optic closure, thermo-mechanical type of ports seals

## EQUIPMENT

Elements	Qty
Dome of the fiber optic closure	1 pcs
Base of the fiber optic closure	1 pcs
Internal cable organiser	1 pcs
Clamp	1 pcs
Installation clamps	2 pcs
Seal	1 pcs
Splice trays holder	1 pcs
Splice tray SCM-C-12H-GY	1 pcs
Seal kit for thermic ports FOBP-U1	1 pcs
Wall-mounting adapter	1 pcs
Accessories set (clip with glue, sand paper, aluminium tape, insulating tape, cable ties)	1 pcs
Velcro tapes for cable tubes arrangement, width 16 mm	20 cm
Membrane type inserts for mechanical ports	2 pcs



FOBP-M 144  
Max. capacity 144 splices



FOBP-M 288  
Max. capacity 288 splices



## VARIANT

FIBRAIN FOBP fiber optic closure 144F, thermo-mechanical type, 1x splice tray holder, 1x SCM-C-12H-GY, 2x membrane insert

FIBRAIN FOBP fiber optic closure 288F, thermo-mechanical type, 1x splice tray holder, 1x SCM-C-12H-GY, 2x membrane insert

## REFERENCE NO.

FOBP-M1-01110

FOBP-M2-01110

# Closures and distribution boxes

## FIBRAIN FOBP-T fiber optic closure, thermic type of ports seals



- Max. capacity 288 splices
- Thermic type of port seals
- 12 round cable entry and 1 oval port for uncut cables
- Pole and wall mounting
- Optional adapter panel
- Built-in organizer for fiber optic tubes
- Possibility of mounting Alubox splitters
  - 1:4, 1:8 mounted in splice tray
  - 1:16 mounted in dedicated handle

✓ **PATENT PENDING**

TECHNICAL SPECIFICATION	FOBP-144	FOBP-288
Max. number of splices	144	288
Max. number of splice trays	12	24
Max. capacity of splice tray	12	12
Range of cable diameter for 8 round ports [mm]	3 – 10	3 – 10
Range of cable diameter for 4 round ports [mm]	6 – 20	6 – 20
Range of cable diameter for oval port [mm]	8 – 25	8 – 25
Max. number of cable entrances	13	13
Dimensions Width x Height x Depth [mm]	293 x 438 x 162	293 x 568 x 162
Leakproofness of ports		Thermic
Working temperature [°C]		-40 to +70
IP protection		IP68
Pull box compatibility:		
- min. chamber diameter [mm]	240	240
- minimum chamber depth [mm]	350	350



# Closures and distribution boxes

## FIBRAIN FOBP-T fiber optic closure, thermic type of ports seals

## EQUIPMENT

Elements	Qty
Dome of the fiber optic closure	1 pcs
Base of the fiber optic closure	1 pcs
Internal cable organiser	1 pcs
Clamp	1 pcs
Installation clamps	2 pcs
Seal	1 pcs
Splice trays holder	1 pcs
Splice tray SCM-C-12H-GY	1 pcs
Seal kit for 8 round ports FOBP.U2	1 pcs
Seal kit for 4 round ports and oval port FOBP.U1	1 pcs
Wall-mounting adapter	1 pcs
Accessories set (clip with glue, sand paper, aluminium tape, insulating tape, cable ties)	1 pcs
Velcro tapes for cable tubes arrangement, width 16 mm	20 cm



FOBP-M 144  
Max. capacity 144 splices



FOBP-M 288  
Max. capacity 288 splices



## VARIANT

## REFERENCE NO.

FIBRAIN FOBP fiber optic closure 144F, thermic type, 1x splice tray holder,  
1x SCM-C-12H-GY

FOBP-T1-01110

FIBRAIN FOBP fiber optic closure 144F, thermic type, 1x splice tray holder,  
1x SCM-C-12H-GY

FOBP-T2-01110

# Closures and distribution boxes

## FIBRAIN FOBP-R-T fiber optic closure, thermic type of ports seals



- Max. capacity 288 splices
- Equipped in fiber organizer
- Thermic type of port seals
- 12 round cable entry and 1 oval port for uncut cables
- Pole and wall mounting
- Optional adapter panel
- Built-in organizer for fiber optic tubes



**PATENT PENDING**

TECHNICAL SPECIFICATION	FOBP-R-T-144	FOBP-R-T-288
Max. number of splices	144	288
Max. number of splice trays	12	24
Max. capacity of splice tray	12	12
Range of cable diameter for 8 round ports [mm]	3 - 10	3 - 10
Range of cable diameter for 4 round ports [mm]	6 - 20	6 - 20
Range of cable diameter for oval port [mm]	8 - 25	8 - 25
Max. number of cable entrances	13	13
Dimensions Width x Height x Depth [mm]	293 x 438 x 162	293 x 568 x 162
Leakproofness of ports	Thermic	
Working temperature [°C]	-40 to +70	
IP protection	IP68	
Pull box compatibility:		
- min. chamber diameter [mm]	240	240
- minimum chamber depth [mm]	350	350

# Closures and distribution boxes

## FIBRAIN FOBP-R-T fiber optic closure, thermic type of ports seals

## EQUIPMENT

Elements	Qty
Dome of fiber optic closure	1 pcs
Base of fiber optic closure	1 pcs
Internal cable organizer	1 pcs
Clamp	1 pcs
Installation clamp	2 pcs
Seal	1 pcs
Splice trays holder	1 pcs
Splice tray SCM-C-12H-GY	1 pcs
Seal kit for 8 round ports FOBPJ2	1 pcs
Seal kit for 4 round ports and oval port FOBPJ1	1 pcs
Wall-mounting adapter	1 pcs
Accessories set (clip with glue, sand paper, aluminium tape, insulating tape, cable ties)	1 pcs
Velcro tapes for cable tubes arrangement, width 16 mm	20 cm



FOBP-R-T 288  
Max. capacity 288 splices



FOBP-R-T 144  
Max. capacity 144 splices



## VARIANT

FIBRAIN FOBP-R fiber optic closure, 144F, thermic type with fiber organiser, 12 x SCM-C-12-GY, 1 x 3-6 mm insert, 1 x 6-8 mm insert, quick mount holder

FIBRAIN FOBP-R fiber optic closure, 144F, thermic type with fiber organiser, 12x SCM-C-12-GY, 1 x 3-6 mm insert, 1 x 6-8 mm insert, quick mount holder

## REFERENCE NO.

FOBP-R-T1-23-1210-000000-000-0-2

FOBP-R-T2-23-1210-000000-000-0-2

# Closures and distribution boxes

## FIBRAIN FOBP-R-M fiber optic closure, thermo-mechanical type of port seals



- Max. capacity 288 splices
- Equipped in fiber organizer
- Thermo and mechanical type of port seals
- 2 cable glands with multiplication inserts, 4 round cable entry and 1 oval port for uncut cables
- Pole and wall mounting
- Optional adapter panel
- Built-in organizer for fiber optic tubes

✓ **PATENT PENDING**

TECHNICAL SPECIFICATION	FOBP-R-M 144	FOBP-R-M-288
Max. number of splices	144	288
Max. number of splice trays	12	24
Max. capacity of splice tray	12	12
Range of cable diameter for 2 mechanical ports	3-6 mm, 4,5-6,5 mm, 6-8 mm, 8-10 mm, flat 8,3 x 4,6 mm, 2-20 mm	
Max. quantity of cable per one mechanic port	4 (insert: 3-6 mm, 6-8 mm, 8-10 mm, flat 8,3 x 4,6 mm), 6 (insert 4,5-6,5mm) X* (membrane type insert 2-20 mm)	
Range of cable diameter for 4 round ports [mm]	6 – 20	6 – 20
Range of cable diameter for oval port [mm]	8 – 25	8 – 25
Max. quantity of cable installed	17	17
Dimensions Width x Height x Depth [mm]	293 x 438 x 162	293 x 568 x 162
Leakproofness of ports	Mechanic and thermic	
Working temperature [°C]	-40 to +70	
IP protection	IP68	
Pull box compatibility:		
- minimum chamber diameter [mm]	240	240
- minimum chamber depth [mm]	350	350

# Closures and distribution boxes

## FIBRAIN FOBP-R-M fiber optic closure, thermo-mechanical type of port seals

### ADDITIONAL EQUIPMENT

Elements	Qty
Dome of fiber optic closure	1 pcs
Base of fiber optic closure	1 pcs
Internal cable organizer	1 pcs
Clamp	1 pcs
Installation clamp	2 pcs
Seal	1 pcs
Splice trays holder	1 pcs
Splice tray SCM-C-12H-GY	1 pcs
Seal kit for thermic ports FOBPU1	1 pcs
Wall-mounting adapter	1 pcs
Accessories set (clip with glue, sand paper, aluminium tape, insulating tape, cable ties)	1 pcs
Velcro tapes for cable tubes arrangement, width 16 mm	20 cm
Membrane type inserts for mechanical ports	2 pcs



FOBP-R-M 144  
Max. capacity 144 splices



FOBP-R-M 288  
Max. capacity 288 splices



### VARIANT

FIBRAIN FOBP-R fiber optic closure, 144F, thermo-mechanical type with fiber organiser, 12 x SCM-C-12-GY splice tray, 1 x 3-6 mm insert, 1 x 6-8 mm insert, quick mount holder

FIBRAIN FOBP-R fiber optic closure, 288F, thermo-mechanical type with fiber organiser, 24 x SCM-C-12-GY splice tray, 1 x 3-6 mm insert, 1 x 6-8 mm insert, quick mount holder







### REFERENCE NO.

FOBP-R-M1-23-1210-000000-000-0-2

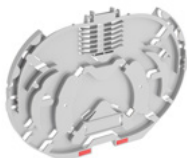
FOBP-R-M2-23-2410-000000-000-0-2

# Closures and distribution boxes

## Additional equipment for FOBP series closure

ADDITIONAL EQUIPMENT:	REFERENCE NO.
 <p>Splice tray</p>	SCM-C-12H-GY
 <p>Splice trays holder (capacity up to 4 x SCM-C-12H-GY)</p>	SCM-C-H-GY
 <p>Adapters – SC SX/E2000 SX</p>	A101-xx, ADR-xx
 <p>Splitters</p>	FPLC-xx in AluBox housing
 <p>Pigtails</p>	G-xx
 <p>Cable reserve frame</p>	SZ-D-FOBP-ZN-P
 <p>Bottom mounting holder for cable reserve frame</p>	UMD-SZ-D-FOBP-ZN-P

# Closures and distribution boxes

## Additional equipment for FOBP series closure



FIBRAIN quick mounting holder for FOBP closure

FOBP.USM



Multiplication insert for mechanical port 4 x 3-6 mm

FOBP.MPI.3-6.BL



Multiplication insert for mechanical port 4 x 6-8 mm

FOBP.MPI.6-8.BL



Multiplication insert for mechanical port 4 x 8-10 mm

FOBP.MPI.8-10.BL



Multiplication insert for mechanical port 4x 8,3-4,6 mm

FOBP.MPI.8.3-4.6.BL



Multiplication insert for mechanical port 6 x 4,5-6,5 mm

FOBP.MPI.4.5-6.5.BL



Membrane type IP54 inserts for mechanical ports

FOBP.MPI.MT.BL



# Closures and distribution boxes

## Additional equipment for FOBP series closure



Accessories set (clip with glue, sand paper, aluminium tape, insulating tape, cable ties)

FOBP.AS



Adapter panel 9 x SC SX for 144F closure

FOBP.AP.09



Adapter panel 18 x SC SX for 288F closure

FOBP.AP.18



Seal kit for thermic ports, heatshinks for oval ports and 4 pcs for round ports for 20 mm cable diameter

FOBP.U1



Seal kit for thermic ports, heatshinks for 8 pcs for round ports for 10 mm cable diameter

FOBP.U2

**FIBRAIN** 

FIBER OPTIC  
MICRODUCT SYSTEM

# Metro- -Jet

We are thrilled to present you our next flyer and this time about MetroJET system that is a multiway ground teletechnical structure.

Due to its design, it provides the installation of many fiber optic microcables into one bundle of single microducts with diameters in the range from 5 to 16 mm.

Therefore, FIBRAIN in its MetroJet system offers a wide range of products for the construction of new ground fiber optic networks, as well as the modernization of existing ones.

→ [www.fibrain.com/systems](http://www.fibrain.com/systems)

# Closures and distribution boxes

## FB8000.41 Fiber optic dome closure



- Max. capacity 144 splices
- Thermic type of port seals
- 4 round cable entry and 1 oval port for uncut cables
- Pole and wall mounting
- Optional adapter panel
- Built-in organizer for fiber optic tubes

### TECHNICAL SPECIFICATION

Max. number of splices	144
Max. number of cassettes	6
Max. capacity of cassettes	24
Range of cable diameter for 4 round ports [mm]	6 - 17
Range of cable diameter for a round port [mm]	6 - 25
Max. number of cable entrances	5
Fiber optic closure dimensions (Ø) x (w) [mm]	230 x 450
Leakproofness of ports	thermic
Working temperature [°C]	-40 to +65
IP protection	IP68
Housing type	MPP

### EQUIPMENT

Elements	Qty
Dome of the fiber optic closure	1 pcs
Base of the fiber optic closure	1 pcs
Dome clamp	1 pcs
Wall / pole Installation hardware	1 pcs
Seal	1 pcs
Splice cassette FB7402	1 pcs
Seal kit for thermic ports	1 pcs
Accessories set (clip with glue, sand paper, aluminum tape, insulating tape, protection tube)	1 pcs

### VARIANT

FIBRAIN Fiber optic dome closure 144F

### REFERENCE NO.

FB8000.41

# Closures and distribution boxes

## FB8000.61 Fiber optic dome closure



- Max. capacity 240 splices
- Thermic type of port seals
- 6 round cable entry and 1 oval port for uncut cables
- Pole and wall mounting
- Built-in organizer for fiber optic tubes
- Optional adapter panel

### TECHNICAL SPECIFICATION

Max. number of splices	240
Max. number of cassettes	10
Max. capacity of cassettes	24
Range of cable diameter for 4 round ports [mm]	6 - 17
Range of cable diameter for a round port [mm]	6 - 25
Max. number of cable entrances	7
Fiber optic closure dimensions (Ø) x (w) [mm]	260 x 465
Leakproofness of ports	thermic
Working temperature [°C]	-40 to +65
IP protection	IP68
Housing type	MPP

### EQUIPMENT

Elements	Qty
Dome of the fiber optic closure	1 pcs
Base of the fiber optic closure	1 pcs
Dome clamp	1 pcs
Wall / pole Installation hardware	1 pcs
Seal	1 pcs
Splice cassette FB7402	1 pcs
Seal kit for thermic ports	1 pcs
Accessories set (clip with glue, sand paper, aluminum tape, insulating tape, protection tube)	1 pcs

### VARIANT

FIBRAIN fiber optic closure, 6 round ports and one oval, equipped with one splice cassette, mounting hardware

### REFERENCE NO.

FB8000.61

# Closures and distribution boxes

## FB8000.AP FIBRAIN adapter panel for FB8000 closure

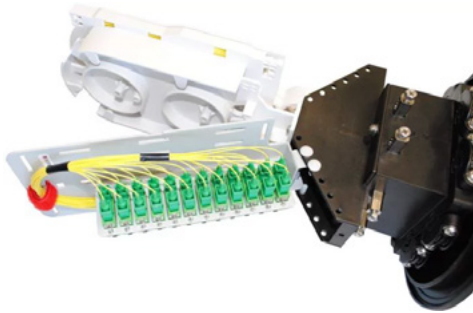

- Max. capacity of 12 SC DX adapters
- Easy installation
- Possibility of mounting Alubox splitters
- Compatible with FB8000.41 i FB8000.61

TECHNICAL SPECIFICATION	FB8000.41	FB8000.61
Max. splice capacity of closure with adapter panel	72	120
Max. number of splice cassettes with adapter panel	3	5
Max. adapter quantity	12 SC DX	
Panel dimensions (w) x (l) x (d) [mm]	110 x 220 x 50	
Working temperature [°C]	-40 – +65	
Material	Powder painted steel	
Colour	RAL 7035	

## VARIANT

## REFERENCE NO.

FIBRAIN adapter panel for 12 SC DX for FB8000 closure

FB8000.AP

# Closures and distribution boxes

## FB-XRA dome closure



- Max. capacity 144 splices
- Thermic type of port seals
- 3 round cable entry and 1 oval port for uncut cables
- Pole and wall mounting
- Built-in organizer for fiber optic tubes

### TECHNICAL SPECIFICATION

Max. number of splices	144
Max. number of cassettes	4
Max. capacity of cassettes	36
Range of cable diameter for 3 round ports [mm]	8 - 16
Max. number of cable entrances	4
Fiber optic closure dimensions (Ø) x (w) [mm]	183 x 320
Leakproofness of ports	thermic
Working temperature [°C]	-40 to +65
IP protection	IP68
Housing type	PP+GF



### VARIANT

### REFERENCE NO.

FIBRAIN FB-XRA fiber optic dome closure, 144F, 3 round ports and one oval, equipped with 1 x splice cassette 36F, mounting hardware	FB-XRA-36
FIBRAIN FB-XRA fiber optic dome closure, 144F, 3 round ports and one oval, equipped with 2 x splice cassettes 36F, mounting hardware	FB-XRA-72
FIBRAIN FB-XRA fiber optic dome closure, 144F, 3 round ports and one oval, equipped with 3 x splice cassettes 36F, mounting hardware	FB-XRA-108
FIBRAIN FB-XRA fiber optic dome closure, 144F, 3 round ports and one oval, equipped with 4 x splice cassettes 36F, mounting hardware	FB-XRA-144





CORE NETWORK

# AirTrack

The construction of a core network – AirTrack network is commonly used in non-metropolitan areas, where it is possible to install fiber optic lines in already built infrastructure.

This solution serves as an alternative to duct networks, which require high financial resources and are extremely time-consuming.

→ [www.fibrain.com](http://www.fibrain.com)





**Suspension clamps**



**Anchoring clamps**



**Spiral anchoring clamps with accessories**



**OBP Closure**



**Fiber optic closures**



**Hook brackets and anchoring clamps**



**Storage brackets**



**AERO cables**

# Closures and distribution boxes

## FIBRAIN OBP-S8 Distribution box



- Max. capacity 36 splices
- SCM-C splice trays for 12 fibers
- Optional adapter panel up to 12 adapters
- Possibility of mounting PLC splitter:
  - 1 pcs of 1 x 8 in each splice tray
  - 2 pcs of 1 x 8 or 1 x 16 in cable organizer
- Dedicated cable holders for inline and drop cables
- Cover with block mechanism and opening angle of 140°
- Optional cable reserve frame
- Equipped with a lock

### TECHNICAL SPECIFICATION

Max. splice number	36
Max. adapters number in patch field holder	12
FO adapters type	SC/E2000
Max. $\varnothing$ of entry cables:	2 x $\varnothing$ 12 mm
• configuration 1	8 x $\varnothing$ 4-10 mm
• configuration 2 (two cables per port)	16 x $\varnothing$ 6 mm
Dimensions: Width x Height x Depth [mm]	225 x 255 x 86
Ambient temperature [°C]	-40 to +65
Closure material	PC + ASA
Splice tray material	ABS V0
Splice tray holder material	ABS V0
Ingress protection	IP54

### ADDITIONAL EQUIPMENT

Elements	REFERENCE NO.
Cable reserve frame: galvanized	SZ-D-S8-ZN
Mounting kit for old Cable reserve frames	SZ-D-S8-PAD
Splice tray	SCM-C-12H-GY
Patch field holder	
Key - for triangle type cylinder lock	FB-KL-T-7
Key - for square type cylinder lock	FB-KL-K-7

# Closures and distribution boxes

## FIBRAIN OBP-S8 Distribution box



View of OBP-S8 equipped in adapter panel and adapters

### Types of cylinder lock



triangle type



square type



notch type

#### VARIANT

FIBRAIN distribution box for 36 splice equipped with splice trays 1 x 12 seals, notch type cylinder lock, black housing

FIBRAIN distribution box for 36 splice equipped with splice trays 1 x 12 with patch field holder 12 x SC with seals, equipped with 12 adapters SCA, notch type cylinder lock, black housing

#### REFERENCE NO.

OBP-S8-300-0000-00000-0-0-0-N-BK

OBP-S8-300-1212-00000-0-2-0-N-BK

# Closures and distribution boxes

## FIBRAIN OBP-S8W Distribution box



- Max. capacity 72 splices
- SCM-A cassettes for 24 fibers
- Adapter panel up to 18 adapters
- Possibility of mounting PLC splitters:
  - 1 pcs inside splice tray
  - 4 pcs of 1 x 8; 1 x 18 in dedicated holder in W2 and W3 insert
- Dedicated cable holders for inline and drop cables
- Cover with block mechanism and opening angle of 140°
- Optional cable reserve frame
- Equipped with a lock

### TECHNICAL SPECIFICATION

Max. splice number	72
Max. adapters number in patch field holder	18
FO adapters type	SC/E2000
Max. $\varnothing$ of entry cables:	2 x $\varnothing$ 16 mm
• configuration 1	8 x $\varnothing$ 4-10 mm
• configuration 2 (two cables per port)	16 x $\varnothing$ 6 mm
Dimensions: Width x Height x Depth [mm]	225 x 255 x 86
Ambient temperature [°C]	-40 to +65
Closure material	PC + ASA
Splice tray material	ABS V0
Splice tray holder material	ABS V0
Ingress protection	IP54

### ADDITIONAL EQUIPMENT

#### Elements

Cable reserve frame: galvanized	SZ-D-S8-ZN
Mounting kit for old Cable reserve frames	SZ-D-S8-PAD
Splice tray	SCM-C-12H-GY
Patch field holder	
Key - for triangle type cylinder lock	FB-KL-T-7
Key - for square type cylinder lock	FB-KL-K-7

# Closures and distribution boxes

## FIBRAIN OBP-S8W Distribution box

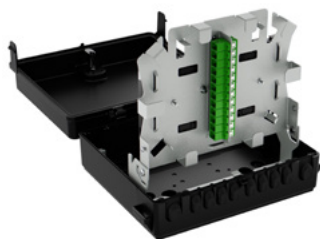

View of OBP-S8W Distribution Box with hinged W1 management plate for 12 adapters

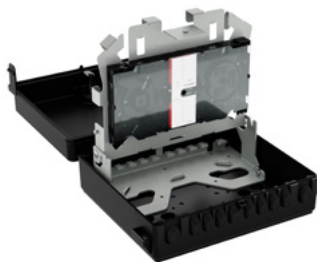

Internal view of OBP-S8W



View of OBP-S8W Distribution Box with hinged W2 management plate for 18 adapters

### Types of cylinder lock



triangle type



square type



notch type

#### VARIANT

FIBRAIN distribution box for 12 adapters, 1 splice trays SCM-A-12H, with seals, notch type cylinder lock, black housing

FIBRAIN distribution box for 18 adapters SC APC, 1 splice trays SCM-A-24H, cable reserve frame, with seals, notch type cylinder lock, black housing

FIBRAIN distribution box for 18 adapters SC APC, 1 splice trays SCM-A-24H, cable reserve frame, with seals, notch type cylinder lock, black housing

#### REFERENCE NO.

OBP-S8W-1-11-0000-0000-0-0-N-BK

OBP-S8W-2-12-0000-0000-0-0-N-BK

OBP-S8W-2-32-1812-0000-0-0-T-BK

# **08.** Cable reserve frames and boxes

# Cable reserve frames and boxes

## FIBRAIN cable reserve frame SZ-A-x



- Easy access to stored cable
- Made of galvanized steel
- Installation on poles and inside manholes

### TECHNICAL SPECIFICATION

	SZ-A-40	SZ-A-60	SZA-A-75
Dimensions: Height x Width x Depth [mm]	400 x 400 x 95	600 x 600 x 95	750 x 750 x 100
Cable capacity	Up to 50 m of 10 mm cable	Up to 80 m of 10 mm cable	Up to 150 m of 10 mm cable



SZ-A-40



SZ-A-60



SZ-A-75

### VARIANT

FIBRAIN cable reserve frame 400 mm

FIBRAIN cable reserve frame 600 mm

FIBRAIN cable reserve frame 750 mm

### REFERENCE NO.

SZ-A-40

SZ-A-60

SZ-A-75



# Cable reserve frames and boxes

## FIBRAIN adjustable cable reserve frame SZ-B-4/6



- Easy access to stored cable
- Made of galvanized steel
- Installation on poles and inside manholes
- Expandable range of cable capacity

### TECHNICAL SPECIFICATION

### SZ-B-4/6

Dimensions: Height x Width x Depth [mm]	400-600 x 400-600 x 110
Cable capacity	Up to 80 m of 10 mm cable



### VARIANT

FIBRAIN adjustable cable reserve frame 400-600 mm

### REFERENCE NO.

SZ-B-4/6

# Cable reserve frames and boxes

## FIBRAIN cable reserve frame with pole holder for FOBP closure



- Easy access to stored cable
- Made of powder painted galvanized steel
- Pole fixation using steel staple
- Holder designed to work with FOBP closures

### TECHNICAL SPECIFICATION

### SZ-D-FOBP-ZN-P

Dimensions: Height x Width x Depth [mm]	719 x 772 x 136
Cable capacity	Ø 6 mm → 350 m Ø 8 mm → 200 m Ø 10 mm → 140 m Ø 12 mm → 100 m Ø 14 mm → 70 m Ø 16 mm → 50 m



View of installed FOBP closure



View of installed FOBP closure

### VARIANT

FIBRAIN cable reserve frame with pole holder for FOBP closure, powder coated galvanized steel

### REFERENCE NO.

SZ-D-FOBP-ZN-P

# Cable reserve frames and boxes

## FIBRAIN SZ-D-S8-ZN pole holder with cable reserve frame for OBP-S8

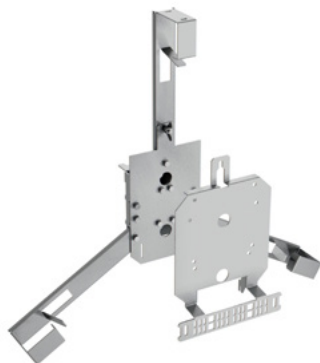

- Easy access to stored cable
- Made of galvanized steel
- Fastening the holder to the pole with a hoop
- Enables quick removal of the distribution box from the holder without the use of tools
- The handle enables the assembly of OBP-S8 boxes

### TECHNICAL SPECIFICATION

### SZ-D-S8-ZN

Dimensions: Height x Width x Depth [mm]	471 x 516 x 116
Cable capacity	Up to 30 m of 10 mm cable



View of installed FOBP closure



View of installed FOBP closure

### VARIANT

### REFERENCE NO.

FIBRAIN pole holder with cable reserve frame for OBP-S8 distribution box

SZ-D-S8-ZN

FIBRAIN pole holder with extended cable reserve frame for OBP-S8

SZ-D-S8-ZN-V2

# Cable reserve frames and boxes

## FIBRAIN SZB-A-x cable reserve case



- Easy access to stored cable
- Casing made of powder painted steel
- Rubber protected edges against cable sheath damage
- Mounting on nail expansion anchors
- Equipped with a lock

TECHNICAL SPECIFICATION

	SZB-A-40	SZB-A-60
Dimensions: Height x Width x Depth [mm]	400 x 400 x 120	400 x 400 x 100
Cable capacity	Up to 50 m for 10 mm cable	Up to 80 m for 10 mm cable



SZB-A-40



SZB-A-60

VARIANT

FIBRAIN cable reserve case 400 mm with lock, RAL 7035 powder painted steel  
 FIBRAIN cable reserve case 600 mm with lock, RAL 7035 powder painted steel

REFERENCE NO.

SZB-A-40  
 SZB-A-60

# Cable reserve frames and boxes

## Cable reserve frame SZB-A-IFDT-B0 for IFDT-B0 cabinet



- Easy access to stored cable
- Made of powder painted steel
- Equipped in hinges ready to mount

### TECHNICAL SPECIFICATION

Dimensions: Height x Width x Depth [mm]	315 x 390 x 65
Cable capacity	Up to 10 m of 10 mm cable

### VARIANT

FIBRAIN Cable reserve frame for IFDT-B0 cabinet

### REFERENCE NO.

SZB-A-IFDT-B0

## Cable reserve frame for IFDT-C0 cabinet

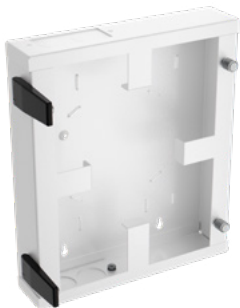

- Easy access to stored cable
- Made of powder painted steel
- Equipped in hinges ready to mount

### TECHNICAL SPECIFICATION

Dimensions: Height x Width x Depth [mm]	315 x 270 x 65
Cable capacity	Up to 5 m of 10 mm cable

### VARIANT

FIBRAIN Cable reserve frame for IFDT-C0 cabinet

### REFERENCE NO.

SZB-A-IFDT-C0

# Cable reserve frames and boxes

## FIBRAIN SZ-DN distance holder



- Allows the installation of the cable reserve frame at a distance of 150 mm or 250 mm from the edge of the pole
- Fixing the distance holder to the frame with screws
- Fastening to the pole using steel tape
- Made of galvanized steel

TECHNICAL SPECIFICATION

	SZ-D-DN150	SZ-D-DN250
Dimensions: Height x Width x Depth [mm]	200 x 164 x 98	200 x 264 x 98



SZ-D-DN (150 mm)



SZ-D-DN (250 mm)

VARIANT

FIBRAIN distance holder for cable reserve frame 150 mm

FIBRAIN distance holder for cable reserve frame 250 mm

REFERENCE NO.

SZ-D-DN150

SZ-D-DN250





# Contact

**FIBRAIN POLAND**  
**36-062 Zaczernie 190F**

phone (+48) 17 866 08 00

(+48) 17 866 08 13

fax (+48) 17 866 08 11

---

e-mail [info@fibrain.com](mailto:info@fibrain.com)

[www.fibrain.com](http://www.fibrain.com)

---

**FIBRAIN** 